

# HARDMETALS



## Agriculture

**Catalogue AG020**

Hard Metals Australia is proudly accredited with the following ISO certifications:  
ISO 9001: 2015 Quality Management Standard  
ISO 14001: 2015 Environmental Management System Standard  
ISO 45001: 2018 Health and Safety Management System

# CONTENTS

About Us.....	1
Stock Codes .....	2
Tillage Tools.....	4
About Our Tools.....	5
For Keech.....	6
For Janke .....	10
Knife Points .....	11
For Conservapak.....	12
Replacement Tynes.....	14
Deep Ripping.....	16
Bolt-ons .....	18
Furrowers .....	20
Flexifit Adapters.....	21
Flexifit Points .....	22
Flexifit Sweeps .....	23
Accessories .....	24
About Accessories.....	25
Fasteners .....	25
Weld-on Blocks .....	26
Adapters.....	27
Other Services.....	28
About Services .....	29
Specials.....	30
Additional Carbide Tiling.....	30
Reworks .....	30
New Products.....	30
OEM Castings .....	31

## Catalogues in the 020 Series

- » **Agriculture (AG020)**
- » **Drilling**
- » **Construction**
- » **Wearparts**





# ABOUT US

It was in the early 20th century that tungsten carbide began to make a huge impact on the industrial world. An incredibly versatile material, it's been used in light bulb filaments, cutting tools, armour piercing ammunition, and jet engines.

The early 1980s saw this wonder material being used heavily in the Australian mining industry. After working with the material there, some key people saw the opportunity to extend tungsten carbide into the agricultural industry. Farmer Bill Staughton, agricultural innovator Barry McFarlane, and entrepreneur Ron Ainge began experimenting with the idea of tungsten carbide protection on tillage tools.

Most tillage tools on the market today are now tungsten carbide protected. An

Australian innovation in this field, it is now used around the world.

Hard Metals Australia, founded by Ron Ainge in 1982, is now one of the biggest tungsten carbide distributors in Australia. As a manufacturer of wear parts and ground engaging tools for a variety of industries, we have a wealth of experience to draw from in designing exceptional tungsten carbide protected products. It is with this experience that we share our Wearparts product line with our customers.



# STOCK CODES

Code	Description
0	<b>Phase Out Product</b> May have remaining stock
1	<b>Stocked Product</b> Generally available immediately
2	<b>Prototype Product</b> No performance guarantee
3	<b>Seasonally Stocked Product</b> May require minimum order
4	[Deprecated]
5	<b>Subassembly Product</b> May not be for sale to end users
6	<b>New Product</b> Stock Code status unconfirmed
7	<b>OEM or Client Product</b> Not for general end user sale
8	<b>Non-Stocked Product</b> Minimum order required
9	<b>Special Product</b> Check with our sales team

Stock codes detail the availability of products. Each product in this catalogue has a code. All codes are subject to change over time and are shown only as a guide.



# TILLAGE TOOLS



# ABOUT OUR TOOLS

Hard Metals Australia has a rich history of designing and manufacturing after market wear-resistant tillage tools.

Our WearMaster range consists of long lasting tillage attachments for most popular farming machines in the Australian market. If you can't find a standard product suitable for your machine, see our 'Specials' section of this catalogue for even more options.



Our FlexiFit range works on an adapter designed for changeout speed and ease of use. Our adapters bolt on to most machines, and any point in the range fits the adapter with a simple roll-pin.

Laboratory testing has shown tungsten carbide has over 50 times the wear life of hardened steel. Our design engineers, often in consultation with in-the-field farmers, identify the weak areas of tillage tools and strategically add tungsten carbide. This keeps points affordable and drastically increases tool lifetime.

Drawings in this catalogue use **red** to represent tungsten carbide tiling. All measurements are in millimetres.

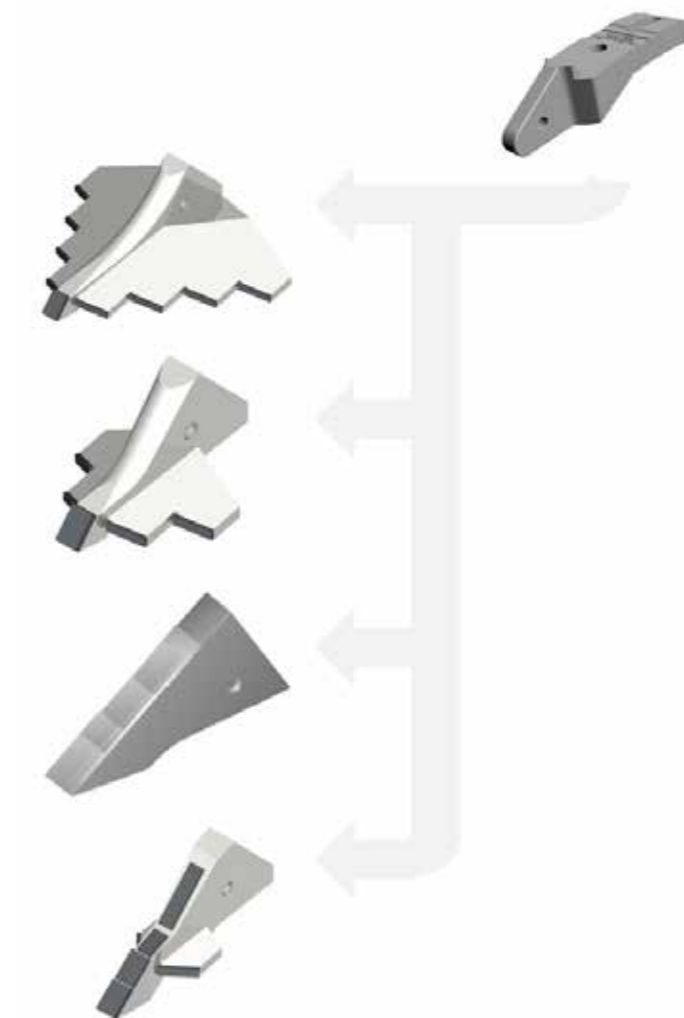

# FOR KEECH

Product	Description	Stock Code		Weight
WM1048	Wide direct drill	1	8	710 G
WM1048-XP	Wide direct drill - Extra protection	3	8	720 G
WM1048-XXP	Wide direct drill - Heavy full protection	3	8	770 G
WM1048R	Rockbreaker wide direct drill	8	8	690 G
WM1048R-XXP	Rockbreaker wide direct drill - Heavy full protection	3	8	730 G

Product	Description	Stock Code		Weight
WM1080	Spear point	1	8	440 G
WM1080-XP	Spear point - Full protection	8	8	450 G
WM1080-XXP	Spear point - Heavy full protection	8	8	480 G

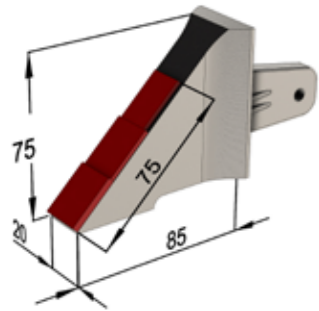

WM1048

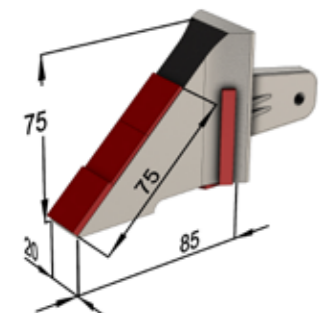

WM1048-XP

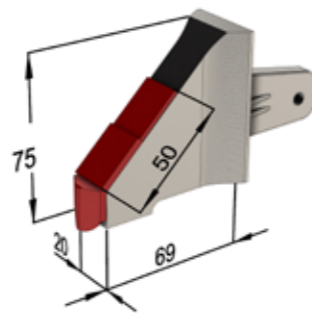

WM1048R

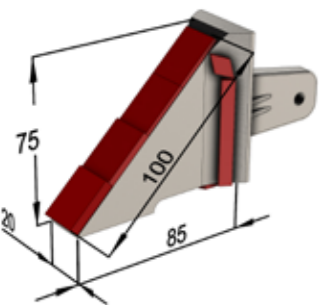

WM1048-XXP

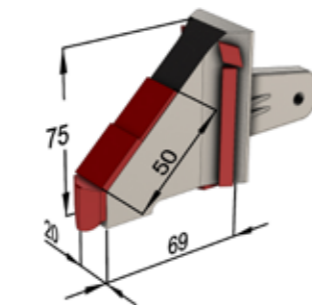

WM1048R-XXP

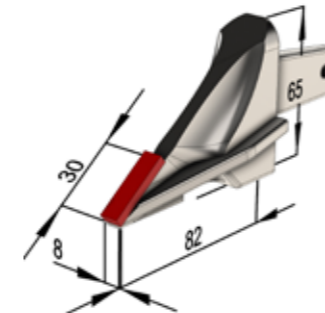

WM1080

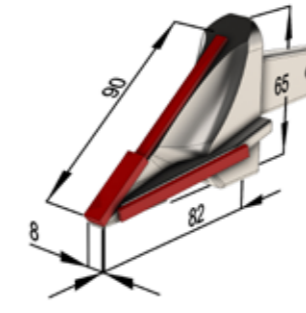



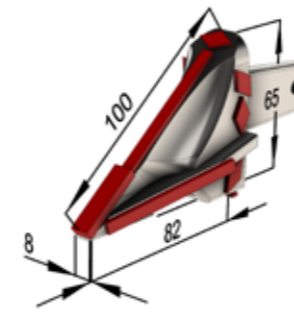

WM1080-XP



WM1080-XXP



Product	Description	Stock Code		Weight
WM1049	71mm short direct drill	 3	 8	430 G
WM1050	90mm regular direct drill	1	8	500 G
WM1050-XP	90mm regular direct drill with extra protection	3	8	520 G
WM1050-XXP	90mm regular direct drill with heavy protection	8	8	550 G

Product	Description	Stock Code		Weight
WM1051	128mm direct drill	 1	 8	830 G
WM1051-XP	128mm direct drill with side protection	3	8	840 G
WM1053-S	150mm long direct drill with side protection	6	8	910 G
WM1053	163mm extra long direct drill with side protection	6	8	1.04 KG
WM1054	Forward angled direct drill	3	8	710 G
WM1054-XP	Forward angled direct drill with side protection	8	8	720 G
WM1052	Winged seeder	3	8	740 G

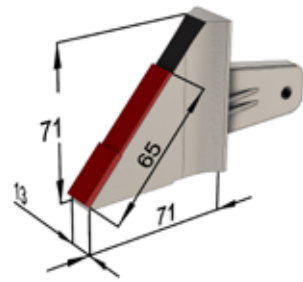

WM1049

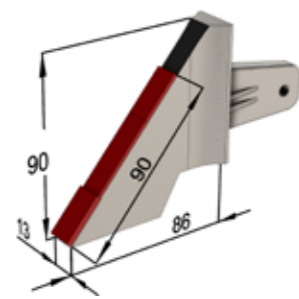

WM1050

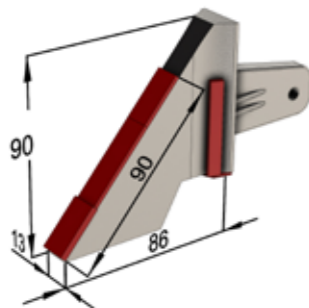

WM1050-XP

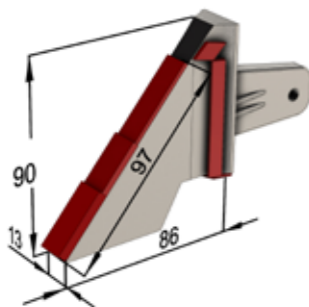

WM1050-XXP



WM1051

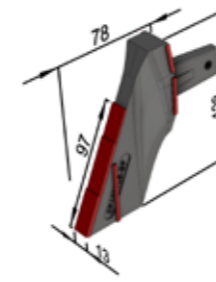

WM1051-XP

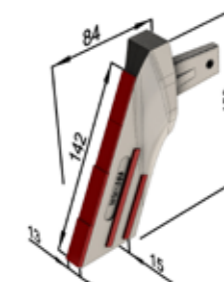

WM1053-S

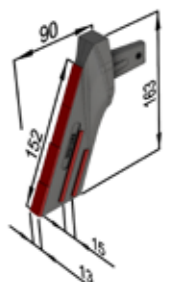

WM1053

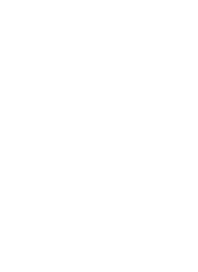

WM1054



WM1054-XP

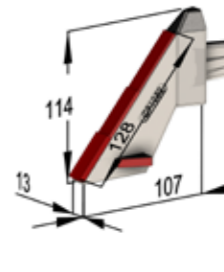

WM1052

# FOR JANKE

# KNIFE POINTS

Product	Description	Stock Code	Weight
WM1088 & WM1088-N	Arrow head point	1  8	710 G
WM1088-N-XP	Arrow head point - Side protection	3 8	720 G
WM1088-N-XXP	Arrow head point - Full protection	3 8	750 G
WM1088-XP12	12mm wide arrow head with heavy nose	8 8	900 G
WM1088-XP19	19mm wide arrow head with long heavy nose	8 8	1.20 KG

Product	Description	Stock Code	Weight
WM1057	Short knife point for Flexicoil	8  8	870 G
WM1058	Knife point for Flexicoil	1 8	1.00 KG
WM1082	Spear point for Gyal	1 8	300 G
WM1082-XP	Spear point for Gyal with extra protection	3 8	360 G
WM1104	Slimwedge knock-on knife point for McCoy	1 8	1.45 KG
WM1090	Slimwedge knock-on winged seeder for McCoy	1 8	1.53 KG

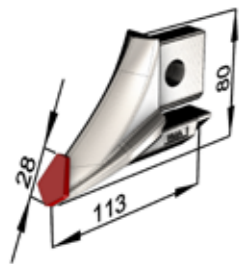

WM1088 | WM1088-N

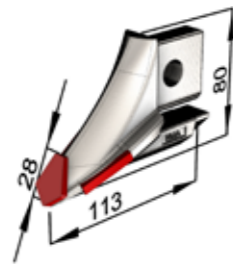

WM1088-N-XP

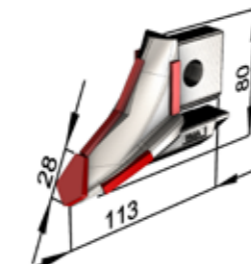

WM1088-N-XXP

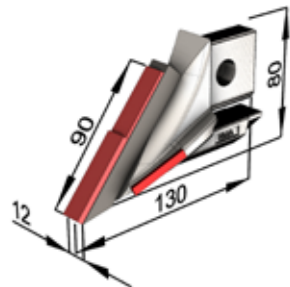

WM1088-XP12

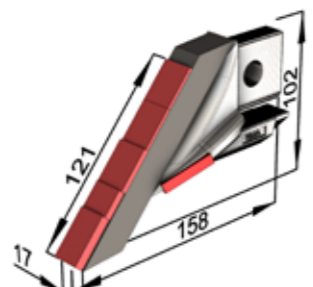

WM1088-XP19

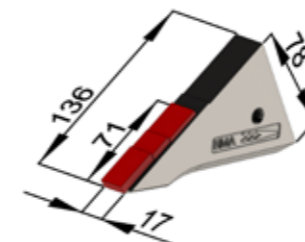

WM1057

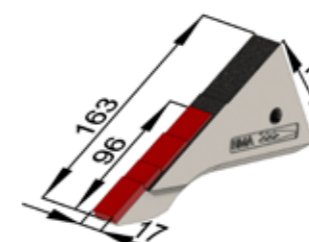

WM1058

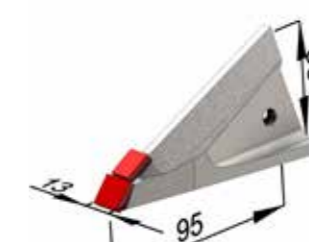

WM1082

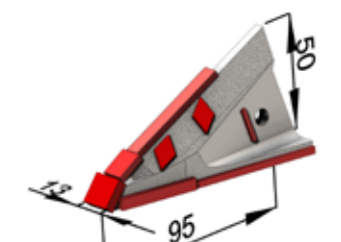

WM1082-XP

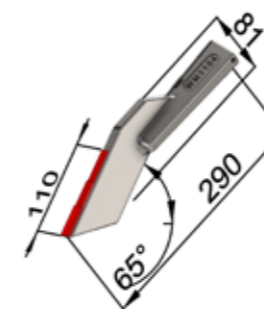

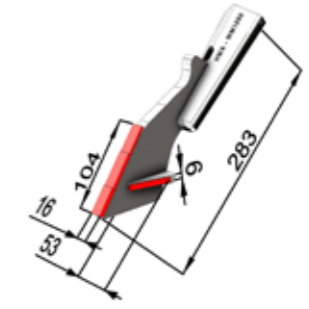

WM1104



WM1090



# FOR CONSERVAPAK

Product	Description	Stock Code		Weight
				
WM1095	Replacement for Conservapak	6	8	910 G
WM1095-XP	Replacement for Conservapak with side protection	6	8	930 G
WM1096	Deep angle replacement for Conservapak	6	8	980 G



WM1095

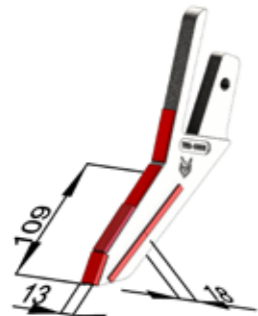

WM1095-XP



WM1096

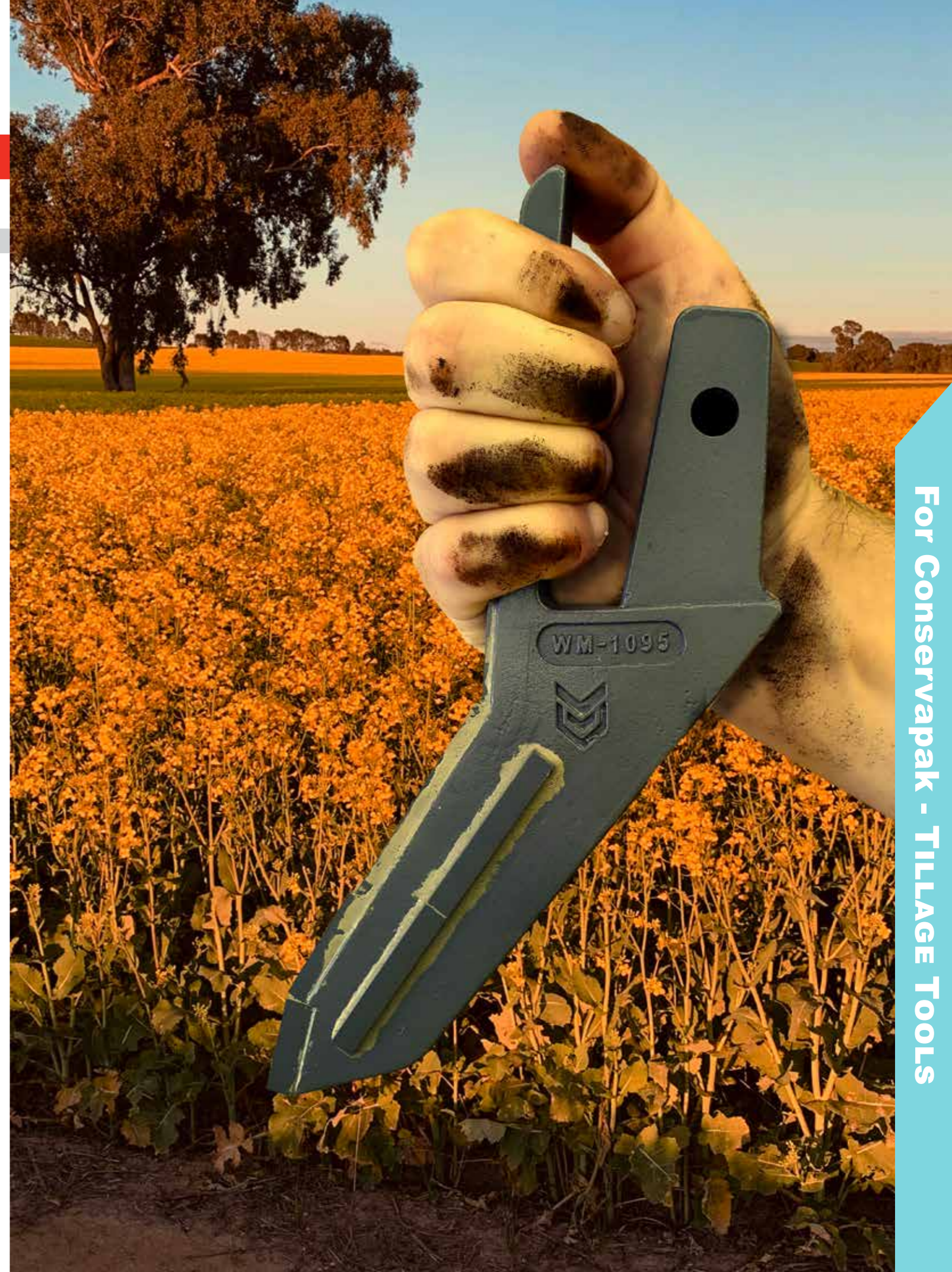



TILLAGE TOOLS - For Conservapak

For Conservapak - TILLAGE TOOLS



# REPLACEMENT TYNES

Product	Description	Stock Code		Weight
				
SH-SKNF409	Tyne for Seedhawk	6	8	1.60 KG
SH-SKNF425	Extended tyne for Seedhawk	6	8	1.70 KG
SH-FKNF430	Flat-foot tyne for Seedhawk	6	8	1.70 KG
SH-FKNF540	Boot tyne for Seedhawk	6	8	2.00 KG
MC2-430XP	Tyne for Morris	6	8	1.90 KG

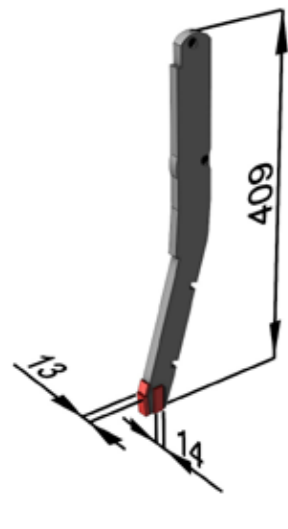

SH-SKNF409



SH-SKNF425

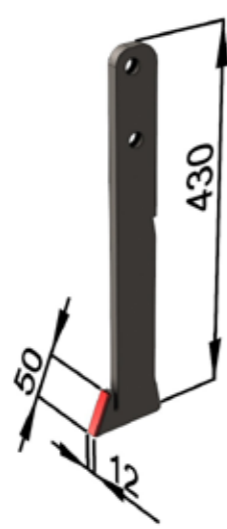

SH-FKNF430

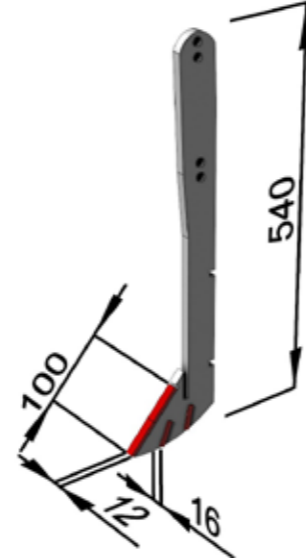





SH-FKNF540



MC2-430XP



# DEEP RIPPING

Product	Description	Stock Code		Weight	Product	Description	Stock Code		Weight
R1024	Boot for Yeomans	 1	 8	2.87 KG	R1010	Boot with pin protection	 3	 8	920 G
R1024-XP	Boot for Yeomans- Rockbreaking full protection	3	8	2.90 KG	R1012	Long boot with pin protection	3	8	1.43 KG
					R1014	Boot for Agrowplow	3	8	1.50 KG
					R1016	Protected adapter for Gessner	1	8	1.33 KG
					R1018	Replaceable wear tip for R1016	1	8	750 G
					R1022	Wide connection ripper boot	8	8	1.88 KG



R1024

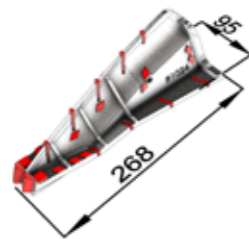

R1024-XP

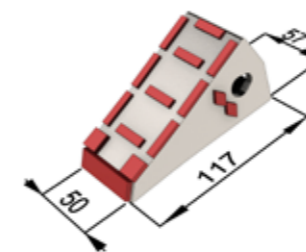

R1010

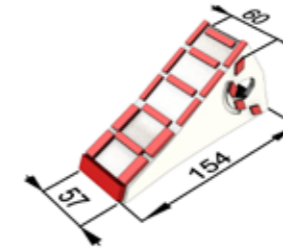

R1012

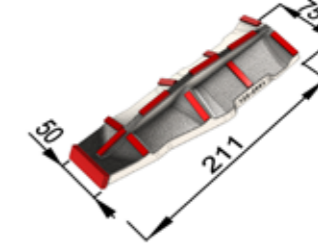

R1014

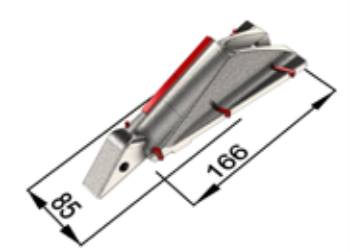

R1016

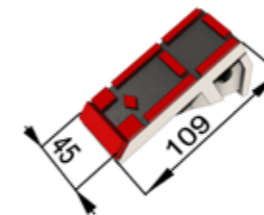



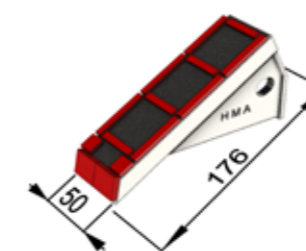

R1018



R1022

# BOLT-ONS

Product	Description	Stock Code		Weight	Product	Description	Stock Code		Weight
									
WM0020-KP	Single-Bolt direct drill	6	8	500 G	WM1084	Baker boot	1	8	930 G
WM0020-KPL	Single-Bolt direct drill	6	8	610 G	WM1084-XP	Baker boot - Extra protection	3	8	950 G
WM2086	Single-Bolt winged seeder	3	8	1.10 KG	WM1084-XXP	Baker boot - Heavy protection	3	8	980 G
WM2088	Double-Bolt winged seeder	1	8	2.75 KG	WM1002	Double-Bolt reversible chisel 2 1/4" centre	3	8	1.86 KG
WM2024	Single-Bolt knife point	1	8	960 G	WM1004	Double-Bolt reversible chisel 3" centre	3	8	1.91 KG
WM1101	Double-Bolt short knife point	8	8	1.15 KG					
WM1102	Double-Bolt knife point	1	8	1.36 KG					
WM1102-XP	Double-Bolt knife point - Extra protection	3	8	1.50 KG					

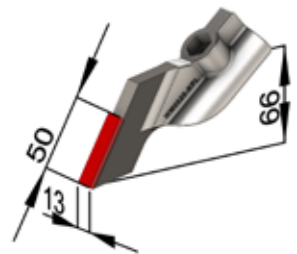

WM0020-KP

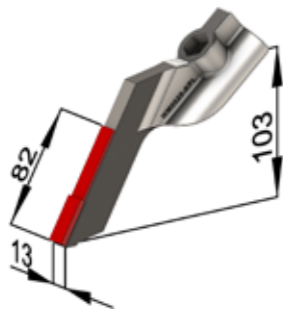

WM0020-KPL

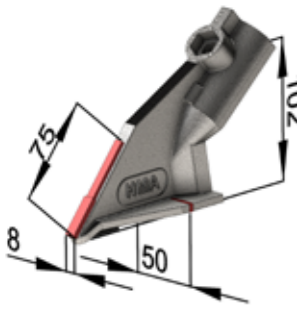

WM2086

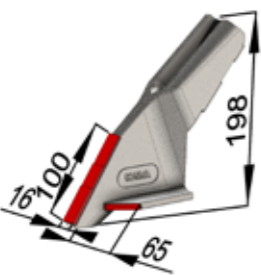

WM2088

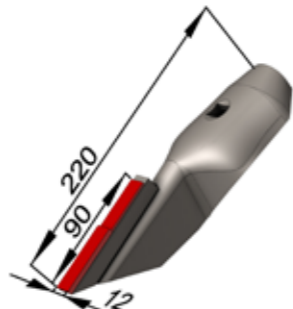

WM2024



WM1101

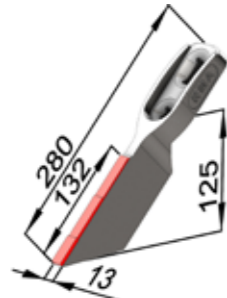

WM1102

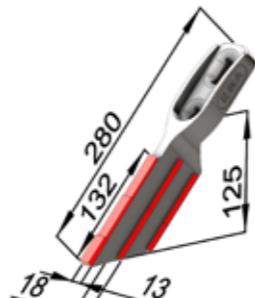

WM1102-XP

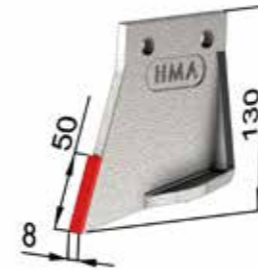

WM1084

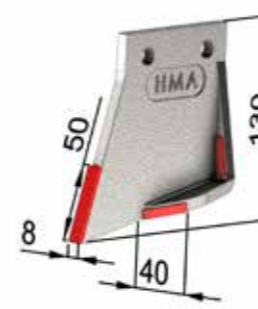

WM1084-XP

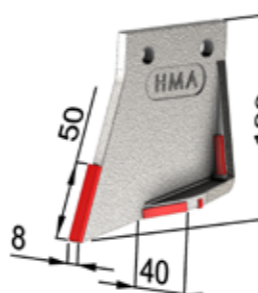

WM1084-XXP

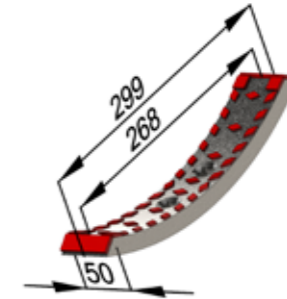
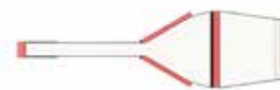

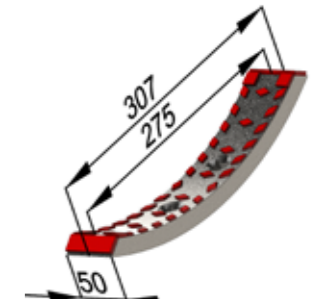

WM1002





WM1004

# FURROWERS

Product	Description	Stock Code		Weight
		 		
RC1008	15" heavy duty furrower	8	8	-
RC1010	20" heavy duty furrower	8	8	-
RC1012	24" heavy duty furrower	8	8	-
RC1014	18" Alabama sweep with nose protection	8	8	5.10 KG
RC1020	24" Alabama sweep with nose protection	8	8	5.60 KG

# FLEXIFIT ADAPTERS

Product	Description	Stock Code		Weight
		 		
FF1000	Bolt-on adapter	1	8	1.13 KG
FF1000-14.5	Bolt-on adapter for 9/16" bolt	8	8	1.13 KG
FF1000-SW	Knock-on slimwedge adapter	1	8	970 G
FF1000P	FlexiFit pin punch	1	8	220 G

FlexiFit adapters are provided at half price when bought together with a FlexiFit point.

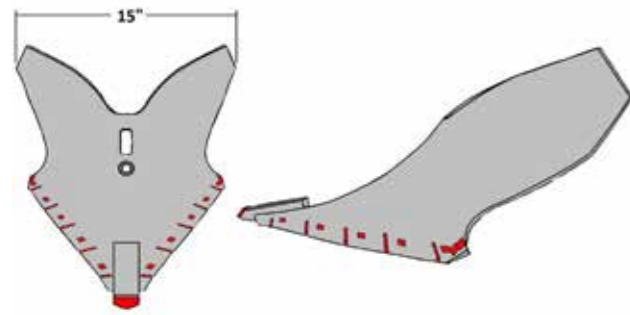

RC1008

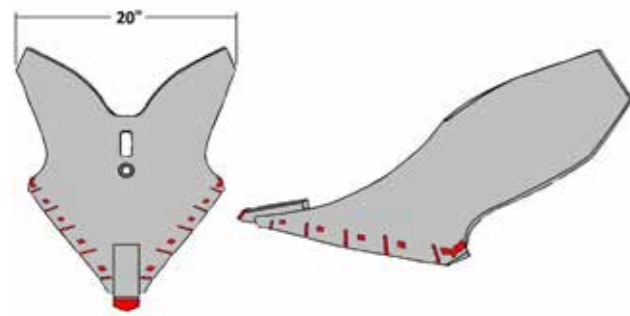

RC1010

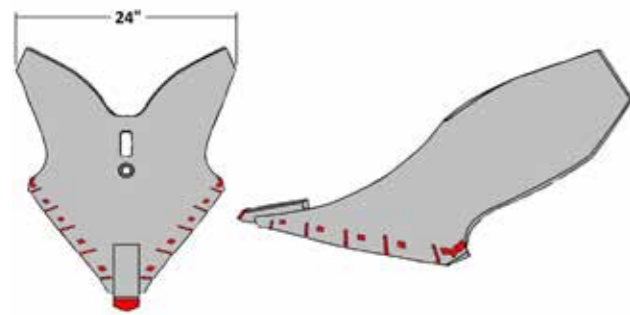

RC1012

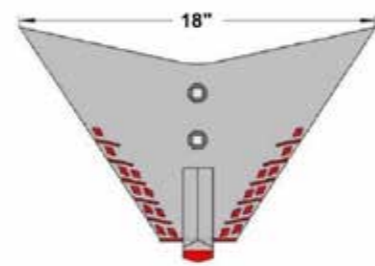

RC1014

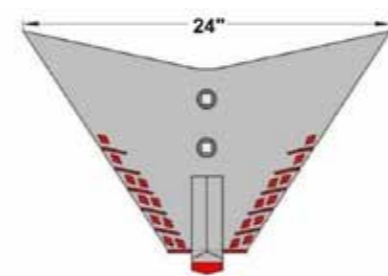

RC1020



FF1000



FF1000-14.5



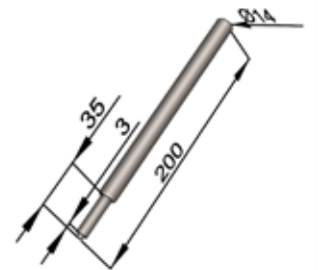

FF1000-SW





FF1000P

# FLEXIFIT POINTS

# FLEXIFIT SWEEPS

Product	Description	Stock Code		Weight
		 		
FF1055	Short knife point	3	8	920 G
FF1055E	Short knife point - Economy carbide	8	8	880 G
FF1055W	Short knife point with wings	8	8	1.05 KG
FF1056	Knife point	1	8	1.06 KG
FF1056-XP	Knife point with side protection	8	8	1.10 KG
FF1056W	Knife point with wings	8	8	1.18 KG
FF1056W-XP	Knife point with wings and side protection	8	8	1.23 KG
FF1056R	Rockbreaker knife point	3	8	920 G
FF1034	Angled knife point	1	8	840 G
FF1034W	Angled knife point with wings	8	8	960 G
FF1003	Seeder point with wings	1	8	700 G
FF1003L	Long seeder point with wings	1	8	800 G

Product	Description	Stock Code		Weight
		 		
FF1004	4" Sweep	3	8	820 G
FF1006	6" Sweep	3	8	1.26 KG
FF1008	8" Sweep	3	8	1.79 KG
FF1009	9" Sweep	3	8	2.15 KG
FF1010	10" Sweep	3	8	2.64 KG
FF1011	11" Sweep	3	8	3.27 KG
FF1012	12" Sweep	3	8	4.20 KG
FF1014	14" Sweep	3	8	4.25 KG

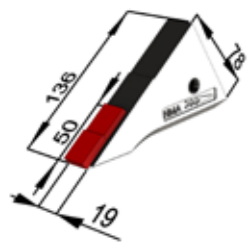

FF1055

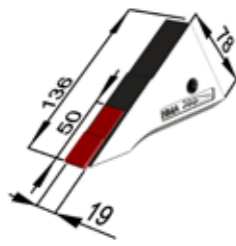

FF1055E

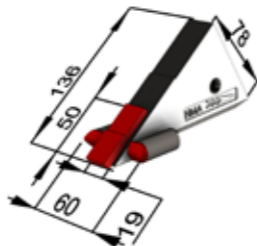

FF1055W

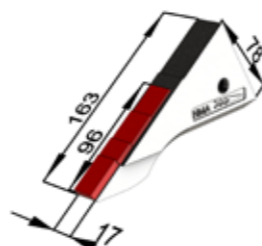

FF1056

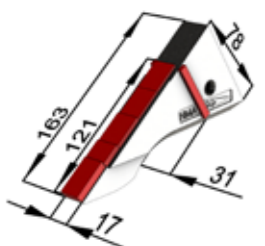

FF1056-XP

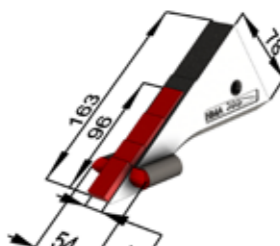

FF1056W

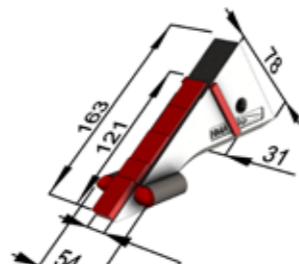

FF1056W-XP

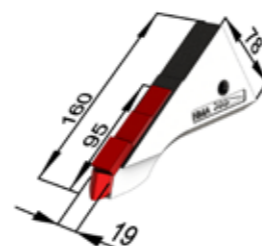

FF1056R

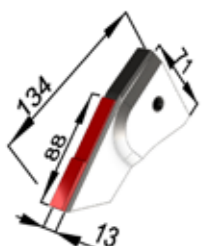

FF1034

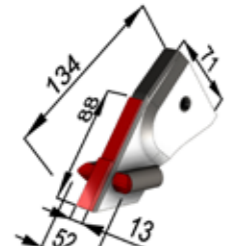

FF1034W

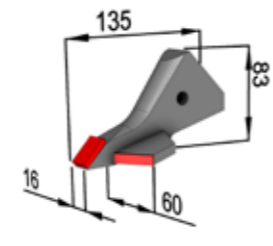

FF1003

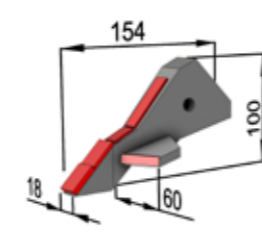

FF1003L

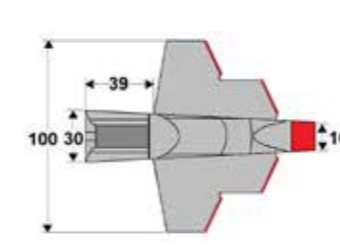

FF1004

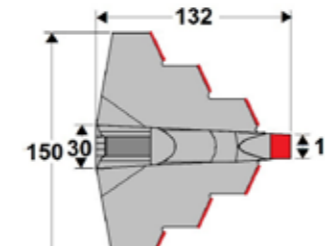

FF1006

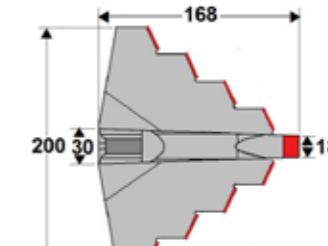

FF1008

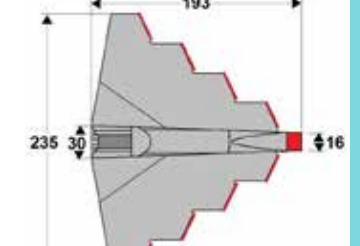

FF1009

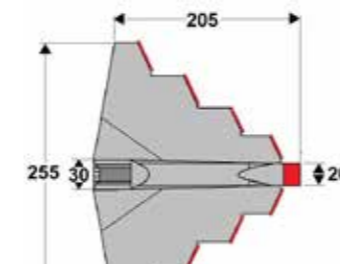

FF1010

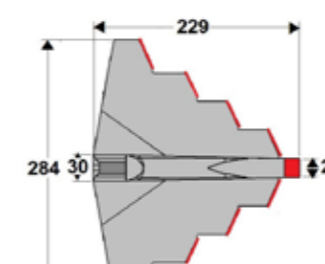

FF1011

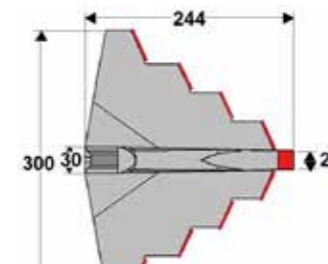

FF1012

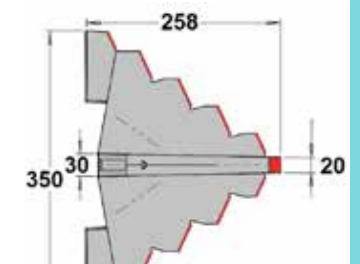

FF1014

TILLAGE TOOLS - FlexiFit Points

FlexiFit Sweeps - TILLAGE TOOLS



# ACCESSORIES

# ABOUT ACCESSORIES

Many of our WearMaster products feature weld-on blocks to substantially change their shape and add heavy protection against impact and wear. Weld-on blocks are available for purchase so you can do it yourself if you already own points that need additional coverage. These come in a range of sizes and feature a heavy duty steel-alloy base with strategic tungsten carbide protection. They are designed to be easy to weld with setups that many farmers already own. Generously preheat both your part and the weld on block before welding for best results.

Required fasteners are included with product purchase. Additional fasteners can be purchased if needed.

# FASTENERS

Product	Description	Stock Code		Weight
				
RP6.4X32	Roll pin to suit WM1082	1	8	5 G
RP6.4X41	Roll pin to suit R1024	1	8	6 G
RP7.9X25.4	Roll pin to suit WM1058	1	8	6 G
RP9.5X32	Roll pin to suit FlexiFit	1	8	11 G
RP9.5X44.5	Roll pin to suit R1016 - R1018	1	8	16 G
WM-KRC	R Clip for Keech style points	1	8	13 G
WM1088-P	Pin for WM1088	1	8	13 G
WM1088-B	Bush for WM1088	1	8	3 G

Required fasteners are included with product purchase. Additional fasteners can be purchased if needed.

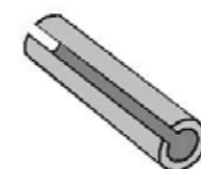

Roll Pin

RP ---

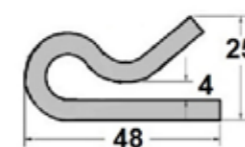

WM-KRC



WM1088-P

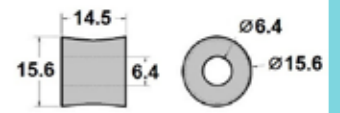

WM1088-B

# WELD-ON BLOCKS

# ADAPTERS

Product	Description	Stock Code		Weight
B1002	Nose block suitable for 12" sweeps and scarifiers	1	8	470 G
B1004	Nose block suitable for 10" sweeps and scarifiers	1	8	180 G
B1006	Nose block with long face protection	1	8	160 G
B1008	Bar with rock-breaker tip	8	8	100 G
B1014	Nose block with half face protection	9	8	200 G
B1022	Nose block for points	1	8	100 G
B1026	Nose block for small sweeps and scarifiers	3	8	170 G
B1028	Nose block for medium sweeps and scarifiers	1	8	350 G
B1032	Nose block with heavy long face protection	8	8	480 G
B1034	Sidebar with rock-breaker tip, good for wings	1	8	60 G
B1012L   B1012R	Left and Right wing protection for sweeps	0	8	40 G

Product	Description	Stock Code		Weight
FF1000	FlexiFit Bolt-on adapter	1	8	1.13 KG
FF1000-14.5	FlexiFit Bolt-on adapter for 9/16" bolt	8	8	1.13 KG
FF1000-SW	FlexiFit Knock-on slimwedge adapter	1	8	970 G
FF1000P	FlexiFit pin punch	1	8	220 G
WM-KWA	Weld-on adapter for Keech style points	1	8	340 G
WM-KBA	Bolt-on adapter for Keech style points	1	8	1.44 KG
WM0020	Bolt-on adapter for Gyrat style points	3	8	410 G

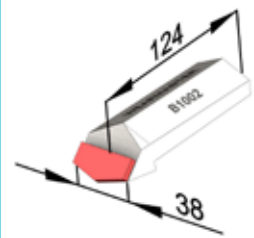

B1002

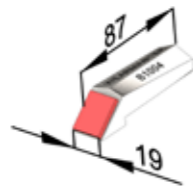

B1004

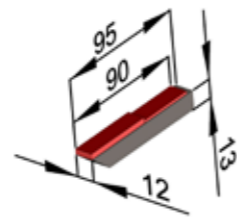

B1006

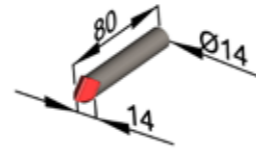

B1008



FF1000



FF1000-14.5



FF1000-SW

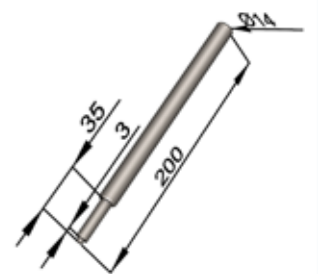

FF1000P

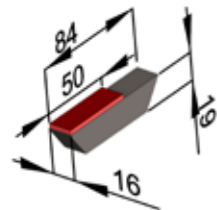

B1014

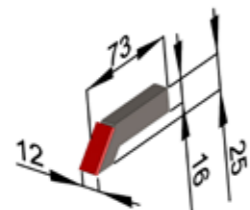

B1022

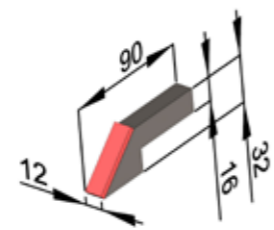

B1026

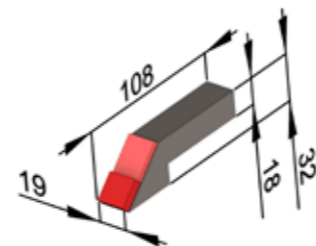

B1028



WM-KWA



WM-KBA

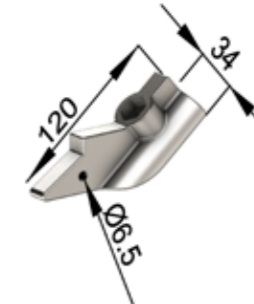

WM0020

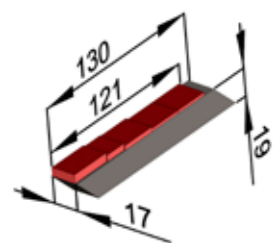

B1032

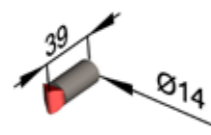

B1034

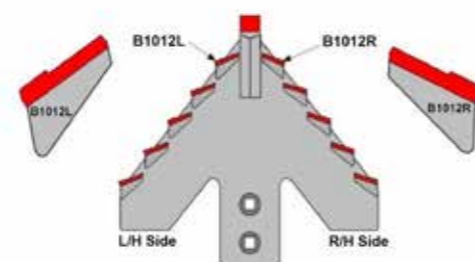

B1012L | B1012R





## OTHER SERVICES

# ABOUT SERVICES

### **Special Products**

As a long term manufacturer of parts designed to resist wear in tough conditions, Hard Metals is uniquely positioned to create custom, lasting points. Our precision casting process utilises a proprietary steel alloy to maximise hardness and toughness for ground engaging tools.

### **OEM Castings**

For Original Equipment Manufacturers (OEMs), we're able to assist in designing and sourcing castings and profiles that have excellent wear properties and can be tungsten carbide plated. We are a proud supplier to many OEMs of various sizes.

# SPECIALS

## Additional Carbide Tiling

Our clients occasionally find that base products they've bought from their suppliers don't perform as well as they should. If you're finding problem wear areas on any steel alloy product, we can add significant protection with tungsten carbide tiling. We have a huge range of tungsten carbide sizes and shapes that can fit any product. Our experienced workshop staff ensure optimal adhesion for strong, durable protection.

## Reworks

Our workshop is equipped with a large machine shop containing manual and CNC machines, as well as a weld bay, part dressing room, and dedicated brazing stations.

Occasionally clients need to modify their existing tooling for upcoming projects. We're able to quickly rework bulk items in whatever ways you need. With a strong team of technical staff, we can assist in ensuring modifications are correct the first time so you can keep working.

## New Products

Hard Metals has experience with the full scope of engineering Agricultural tools for people with unique problems or OEM distributors. We've brought designs from first thought all the way through to final product for many clients.



# OEM CASTINGS

We can reliably source bulk castings in a range of materials. Hard Metals uses a proprietary steel alloy similar to what is used on digging teeth in the excavation industry. It is designed to resist wear in Agricultural applications that is also available to our customers.

Typically, parts are made using a lost wax casting process outlined below. Part tolerance and part finish can be tightened or loosened from CT-5 to CT-9 depending on the required performance and economy.

### 1. TOOLING

A high precision inverted version of the part is CNC machined.



### 2. WAX INJECTION

The inverted part is filled with a special wax. This is a high quality wax version of your finished product.

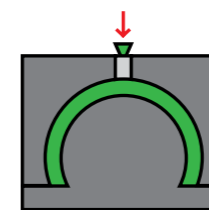

### 3. SHELL COATING

The wax is dipped in several layers of liquid ceramic coating then left to dry.

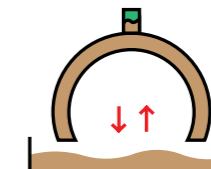

### 4. DEWAX

Wax is melted and pulled away, leaving just the ceramic shell behind.

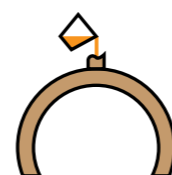
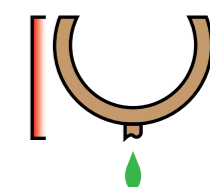

Molten steel alloy is poured into the ceramic shell and left to set.

### 5. POURING



The ceramic is broken from the hardened steel part.

### 6. SHELL REMOVAL



The part is cleaned up and surface treated or heat treated as required.

### 7. FINISH



Technical staff assess the part to ensure the quality of the finish and dimensional accuracy.

### 8. QUALITY ASSURANCE



OTHER SERVICES - Specials

OEM Castings - OTHER SERVICES

# HARD METALS AUSTRALIA PTY LIMITED – TERMS & CONDITIONS OF TRADE

**1. DEFINITIONS**  
1.1 "Contract" means the terms and conditions contained herein, together with any quotation, order, invoice or other document or amendments expressed to be supplemental to this Contract.  
1.2 "HMA" means Hard Metals Australia Pty Limited, its successors and assigns or any person acting on behalf of and with the authority of Hard Metals Australia Pty Limited.  
1.3 "Client" means the persons, entities or any person acting on behalf of and with the authority of the Client requesting HMA to provide the Services as specified in any proposal, quotation, order, invoice or other documentation, and:  
(a) if there is more than one Client, is a reference to each Client jointly and severally, and  
(b) if the Client is a partnership, it shall bind each partner jointly and severally, and  
(c) if the Client is a part of a Trust, shall be bound in their capacity as a trustee, and  
(d) includes the Client's executors, administrators, successors and permitted assigns.  
1.4 "Goods" means all Goods or Services supplied by HMA to the Client at the Client's request 9.3 from time to time (where the context so permits the terms "Goods" or "Services" shall be interchangeable for the other).  
1.5 "Confidential Information" means information of a confidential nature whether oral, written or in electronic form including, but not limited to, this Contract, either party's intellectual property, operational information, know-how, trade secrets, financial and commercial affairs, contracts, client information (including but not limited to, "Personal Information" such as name, address, D.O.B, occupation, driver's license details, electronic contact (email, Facebook or Twitter details), medical insurance details or next of kin and other contact information (where applicable), previous credit applications, credit history) and pricing details.  
1.6 "Cookies" means small files which are stored on a user's computer. They are designed to hold a modest amount of data (including Personal Information) specific to a particular client and website, and can be accessed either by the web server or the client's computer. If the Client does not wish to allow Cookies to operate in the background when ordering from the website, then the Client shall have the right to enable / disable the Cookies first by selecting the option to enable / disable provided on the website, prior to ordering Goods via the website.  
1.7 "Price" means the Price payable (plus any GST where applicable) for the Goods as agreed between HMA and the Client in accordance with clause 5 below.  
1.8 "GST" means Goods and Services Tax (GST) as defined within the 'A New Tax System (Goods and Services Tax) Act 1999' (Cth).  
**2. ACCEPTANCE**  
2.1 The Client is taken to have exclusively accepted and is immediately bound, jointly and severally, by these terms and conditions if the Client places an order for or accepts delivery of 9.7 the Goods.  
2.2 In the event of any inconsistency between the terms and conditions of this Contract and any 9.8 other prior document or schedule that the parties have entered into, the terms of this Contract 9.9 shall prevail.  
2.3 Any amendment to the terms and conditions contained in this Contract may only be amended in writing by the consent of both parties.  
2.4 Electronic signatures shall be deemed to be accepted by either party providing that the 10. parties have complied with Section 9 of the Electronic Transactions Act 2000 or any other 10.1 applicable provisions of that Act or any Regulations referred to in that Act.  
**3. ERRORS AND OMISSIONS**  
3.1 The Client acknowledges and accepts that HMA shall, without prejudice, accept no liability in respect of any alleged or actual error(s) and/or omission(s):  
(a) resulting from an inadvertent mistake made by HMA in the formation and/or administration of this Contract; and/or  
(b) contained in/omitted from any literature (hard copy and/or electronic) supplied by HMA in respect of the Services.  
3.2 In the event such an error and/or omission occurs in accordance with clause 3.1, and is not attributable to the negligence and/or wilful misconduct of HMA, the Client shall not be entitled to treat this Contract as repudiated nor render it invalid.  
**4. CHANGE IN CONTROL**  
4.1 The Client shall give HMA not less than fourteen (14) days prior written notice of any proposed change of ownership of the Client and/or any other change in the Client's details (including but not limited to, changes in the Client's name, address, and contact phone or fax numbers, change of business practice). The Client shall be liable for any loss incurred by HMA as a result of the Client's failure to comply with this clause.  
**5. PRICE AND PAYMENT**  
5.1 At HMA's sole discretion, the Price shall be either:  
(a) as indicated on any invoice provided by HMA to the Client; or  
(b) the Price as at the date of delivery of the Goods according to HMA's current price list; or  
(c) HMA's quoted price (subject to clause 5.2) which will be valid for the period stated in the quotation or otherwise for a period of thirty (30) days.  
5.2 HMA reserves the right to change the Price if a variation to HMA's quotation is requested. Any variation as a result of increases to HMA in the cost of materials and labour, or fluctuations in currency exchange rates, will be charged for on the basis of HMA's quotation and will be shown as variations on the invoice. The Client shall be required to respond to any variation submitted by HMA within ten (10) working days. Failure to do so will entitle HMA to add the cost of the variation to the Price. Payment for all variations must be made in full at the time of their completion.  
5.3 Time for payment for the Goods being of the essence, the Price will be payable by the Client on the date's determined by HMA, which may be:  
(a) payment shall be due on the Client's order for the Goods; or  
(b) for approved Client's, thirty (30) days following the date of invoice; or  
(c) the date specified on any invoice or other form as being the date for payment; or  
5.4 Payment may be made by cash, cheque, bank cheque, electronic-on-line banking, credit card (a surcharge may apply per transaction), or by any other method as agreed to between the Client and HMA.  
5.5 The Client shall not be entitled to set off against, or deduct from the Price, any sums owed or claimed to be owed to the Client by HMA nor to withhold payment of any invoice because part of that invoice is in dispute.  
5.6 Unless otherwise stated the Price does not include GST. In addition to the Price the Client must pay to HMA an amount equal to any GST HMA must pay for any supply by HMA under this or any other contract for the sale of the Goods. The Client must pay GST without deduction or set off of any other amounts, at the same time and on the same basis as the Client pays the Price. In addition, the Client must pay any other taxes and duties that may be applicable in addition to the Price except where they are expressly included in the Price.  
**6. DELIVERY OF GOODS**  
6.1 Delivery ("Delivery") of the Goods is taken that the Goods are delivered ex-warehouse and, unless otherwise stated, dispatched by HMA's nominated carrier (and in accordance with that carrier's current rates).  
6.2 Delivery of the Goods to the Client's agent, carrier or representative shall constitute delivery of the Goods by HMA to the Client for the purposes of this Contract.  
6.3 The costs of delivery are the responsibility of the Client and are in addition to the Price (and where applicable charged to the Client's account).  
6.4 The Client shall make all arrangements necessary to take delivery of the Goods whenever they are tendered for delivery. In the event that the Client is unable to take delivery of the Goods as arranged then HMA shall be entitled to charge a reasonable fee for redelivery.  
6.5 Where it is arranged that the Client or the Client's nominated carrier, is to collect the Goods; notification that the Goods are available for collection shall be deemed as delivery of the Goods. Failure to collect the Goods will not be accepted as mitigating the Client's obligation to make payment within the specified terms.  
6.6 At HMA's sole discretion, storage fees may be charged for any Goods that have not been collected by the Client after twenty-one (21) days after HMA has notified the Client that the Goods are available for collection.  
6.7 The Client acknowledges that the delivery date specified on the order confirmation is an estimate only, based on information available at that time. HMA reserves the right to cancel delivery of the Goods (as per clause 14.2) where it is deemed (at HMA's sole discretion) that the supply of the Goods will not meet the Client's specified terms and requirements, and/or it will expose HMA to unnecessary risk.  
6.8 HMA may deliver the Goods by separate instalments. Each separate instalment shall be invoiced and paid in accordance with the provisions in these terms and conditions.  
6.9 The Client shall take delivery of the Goods tendered notwithstanding that the quantity so delivered shall be either greater or lesser than the quantity purchased provided that:  
(a) such discrepancy in quantity shall not exceed five percent (5%); and  
(b) the Price shall be adjusted pro rata to the discrepancy.  
6.10 HMA shall not be responsible for the non-delivery of the Goods other than by its nominated carrier.  
6.11 The failure of HMA to deliver shall not entitle either party to treat this Contract as repudiated.  
6.12 HMA shall not be liable for any loss or damage whatsoever due to failure by HMA to deliver the Goods (or any of them) promptly or at all, where due to circumstances beyond the control of HMA.  
**7. RISK**  
7.1 Risk of damage to or loss of the Goods passes to the Client on Delivery and the Client must insure the Goods on or before Delivery.  
7.2 If any of the Goods are damaged or destroyed following delivery but prior to ownership passing to the Client, HMA is entitled to receive all insurance proceeds payable for the Goods. The production of these terms and conditions by HMA is sufficient evidence of HMA's rights to receive the insurance proceeds without the need for any person dealing with HMA to make further enquiries.  
7.3 If the Client requests HMA to leave Goods outside HMA's premises for collection or to deliver the Goods to an unattended location, then such Goods shall be left at the Client's sole risk.  
**8. TITLE**  
8.1 HMA and the Client agree that ownership of the Goods shall not pass until:  
(a) the Client has paid HMA all amounts owing to HMA; and  
(b) the Client has met all of its other obligations to HMA.  
8.2 HMA shall retain title to the Goods until payment in full. HMA shall not be deemed to be payment until that form of payment has been honoured, cleared or recognised.  
8.3 It is further agreed that, until ownership of the Goods passes to the Client in accordance with clause 8.1:  
(a) the Client is only a bailee of the Goods and must return the Goods to HMA on request.  
(b) the Client holds the benefit of the Client's insurance of the Goods on trust for HMA and must pay to HMA the proceeds of any insurance in the event of the Goods being lost, damaged or destroyed.  
(c) the Client must not sell, dispose, or otherwise part with possession of the Goods other than in the ordinary course of business and for market value. If the Client sells, disposes or parts with possession of the Goods then the Client must hold the proceeds of any such act on trust for HMA and must pay or deliver the proceeds to HMA on demand.  
(d) the Client should not convert or process the Goods or intermix them with other goods but if the Client does so then the Client holds the resulting product on trust for the benefit of HMA and must sell, dispose of or return the resulting product to HMA as it so directs.  
(e) the Client irrevocably authorises HMA to enter any premises where HMA believes the Goods are kept and recover possession of the Goods.  
(f) HMA may recover possession of any Goods in transit whether or not delivery has occurred.  
(g) the Client shall not charge or grant an encumbrance over the Goods nor grant nor otherwise give away any interest in the Goods while they remain the property of HMA.  
(h) HMA may commence proceedings to recover the Price of the Goods sold 15.1 notwithstanding that ownership of the Goods has not passed to the Client.  
**PERSONAL PROPERTY SECURITIES ACT 2009 ("PPSA")**  
In this clause financing statement, financing change statement, security agreement, and security interest has the meaning given to it by the PPSA.  
Upon assenting to these terms and conditions in writing the Client acknowledges and agrees that these terms and conditions constitute a security agreement for the purposes of the PPSA and creates a security interest in all Goods and/or collateral (account) – being a monetary obligation of the Client to HMA for Services – that may or may not have previously been supplied and that will be supplied in the future by HMA to the Client.  
The Client undertakes to:  
(a) promptly sign any further documents and/or provide any further information (such information to be complete, accurate and up-to-date in all respects) which HMA may 15.2 reasonably require to;  
(i) register a financing statement or financing change statement in relation to a security interest on the Personal Property Securities Register;  
(ii) register any other document required to be registered by the PPSA; or  
(iii) correct a defect in a statement referred to in clause 9.3(a)(i) or 9.3(a)(ii);  
(b) indemnify, and upon demand reimburse, HMA for all expenses incurred in registering a financing statement or financing change statement on the Personal Property Securities Register established by the PPSA or releasing any Goods charged thereon;  
(c) not register a financing change statement in respect of a security interest without the prior written consent of HMA;  
(d) not register, or permit to be registered, a financing statement or a financing change statement in relation to the Goods and/or collateral (account) in favour of a third party without the prior written consent of HMA;  
(e) immediately advise HMA of any material change in its business practices of selling the Goods which would result in a change in the nature of proceeds derived from such sales.  
HMA and the Client agree that sections 96, 115 and 125 of the PPSA do not apply to the security agreement created by these terms and conditions.  
The Client waives their rights to receive notices under sections 95, 118, 121(4), 130, 132(3) 15.4 (d) and 132(4) of the PPSA.  
The Client waives their rights as a grantor and/or a debtor under sections 142 and 143 of the PPSA.  
Unless otherwise agreed to in writing by HMA, the Client waives their right to receive a verification statement in accordance with section 157 of the PPSA.  
The Client must unconditionally ratify any actions taken by HMA under clauses 9.3 to 9.5. Subject to any express provisions to the contrary (including those contained in this clause 9) nothing in these terms and conditions is intended to have the effect of contracting out of any 15.5 of the provisions of the PPSA.  
**SECURITY AND CHARGE**  
In consideration of HMA agreeing to supply the Goods, the Client charges all of its rights, title and interest (whether joint or several) in any land, realty or other assets capable of being charged, owned by the Client either now or in the future, to secure the performance by the Client of its obligations under these terms and conditions (including, but not limited to, the payment of any money).  
The Client indemnifies HMA from and against all HMA's costs and disbursements including legal costs on a solicitor and own client basis incurred in exercising HMA's rights under this clause.  
The Client irrevocably appoints HMA and each director of HMA as the Client's true and lawful attorneys to perform all necessary acts to give effect to the provisions of this clause 10 including, but not limited to, signing any document on the Client's behalf.  
**DEFECTS, WARRANTIES AND RETURNS, COMPETITION AND CONSUMER ACT 2010 (CCA)**  
The Client must inspect the Goods on delivery and must within fourteen (14) days of delivery notify HMA in writing of any evident defect/damage, shortage in quantity, or failure to comply with the description or quote. The Client must notify any other alleged defect in the Goods as soon as reasonably possible after any such defect becomes evident. Upon such notification the Client must allow HMA to inspect the Goods.  
Under applicable State, Territory and Commonwealth Law (including, without limitation the CCA), certain statutory implied guarantees and warranties (including, without limitation the statutory guarantees under the CCA) may be implied into these terms and conditions (Non-Excluded Guarantees).  
HMA acknowledges that nothing in these terms and conditions purports to modify or exclude the Non-Excluded Guarantees.  
Except as expressly set out in these terms and conditions or in respect of the Non-Excluded Guarantees, HMA makes no warranties or other representations under these terms and conditions including but not limited to the quality/suitability of the Goods. HMA's liability in respect of these warranties is limited to the fullest extent permitted by law.  
If the Client is a consumer within the meaning of the CCA, HMA's liability is limited to the extent permitted by section 64A of Schedule 2.  
If HMA is required to replace the Goods under this clause or the CCA, but is unable to do so, HMA may refund any money the Client has paid for the Goods.  
If the Client is not a consumer within the meaning of the CCA, HMA's liability for any defect or damage in the Goods is:  
(a) limited to the value of any express warranty or warranty card provided to the Client by HMA at HMA's sole discretion;  
(b) limited to any warranty to which HMA is entitled, if HMA did not manufacture the Goods; or  
(c) otherwise negated absolutely.  
Subject to this clause 11, returns will only be accepted provided that:  
(a) the Client has complied with the provisions of clause 11.1; and  
(b) HMA has agreed that the Goods are defective; and  
(c) the Goods are returned within a reasonable time at the Client's cost (if that cost is not 16.1 significant); and  
(d) the Goods are returned in as close a condition to that in which they were delivered as is possible.  
Notwithstanding clauses 11.1 to 11.8 but subject to the CCA, HMA shall not be liable for any defect or damage which may be caused or partly caused by or arise as a result of:  
(a) the Client failing to properly maintain or store any Goods;  
(b) the Client using the Goods for any purpose other than that for which they were designed; 17.1  
(c) the Client continuing the use of any Goods after any defect became apparent or should 17.2 have become apparent to a reasonably prudent operator or user;  
(d) the Client failing to follow any instructions or guidelines provided by HMA;  
(e) fair wear and tear, any accident, or act of God.  
Goods ordered as specials, or stock code 9 Goods are not acceptable for credit or return, except under special circumstances.  
HMA may in its absolute discretion accept non-defective Goods for return in which case HMA may require the Client to pay handling fees of up to ten percent (10%) of the value of the returned Goods plus any freight costs.  
Notwithstanding anything contained in this clause if HMA is required by a law to accept a 17.2 return then HMA will only accept a return on the conditions imposed by that law.  
**INTELLECTUAL PROPERTY**  
18. Where HMA has designed, drawn or developed Goods for the Client, then the copyright in 18.1 any designs and drawings and documents shall remain the property of HMA. Under no circumstances may such designs, drawings and documents be used without the express written approval of HMA.  
The Client warrants that all designs, specifications or instructions given to HMA will not cause HMA to infringe any patent, registered design or trademark in the execution of the Client's order and the Client agrees to indemnify HMA against any action taken by a third party against HMA in respect of any such infringement.  
The Client agrees that HMA may (at no cost) use for the purposes of marketing or entry into any competition, any documents, designs, drawings or Goods which HMA has created for the Client.  
**DEFAULT AND CONSEQUENCES OF DEFAULT**  
19. Interest on overdue invoices shall accrue daily from the date when payment becomes due, 19.1 until the date of payment, at a rate of two and a half percent (2.5%) per calendar month (and at HMA's sole discretion such interest shall compound monthly at such a rate) after as well as before any judgment.  
If the Client owes HMA any money the Client shall indemnify HMA from and against all costs 19.2 and disbursements incurred by HMA in recovering the debt (including but not limited to 19.1 internal administration fees, legal costs on a solicitor and own client basis, HMA's contract default fee, and bank discount fees).  
Further to any other rights or remedies HMA may have under this Contract, if a Client has made payment to HMA, and the transaction is subsequently reversed, the Client shall be liable for the amount of the reversed transaction, in addition to any further costs incurred by HMA under this clause 13 where it can be proven that such reversal is found to be illegal, fraudulent or in contravention to the Client's obligations under this Contract.  
Without prejudice to HMA's other remedies at law HMA shall be entitled to cancel all or any 19.3 part of any order of the Client which remains unfulfilled and all amounts owing to HMA shall, whether or not due for payment, become immediately payable if:  
(a) any money payable to HMA becomes overdue, or in HMA's opinion the Client will be unable to make a payment when it falls due;  
(b) the Client has exceeded any applicable credit limit provided by HMA;  
(c) the Client becomes insolvent, convenes a meeting with its creditors or proposes or enters into an arrangement with creditors, or makes an assignment for the benefit of its 19.4 creditors; or  
(d) a receiver, manager, liquidator (provisional or otherwise) or similar person is appointed in respect of the Client or any asset of the Client.  
**CANCELLATION**  
19.7 Without prejudice to any other remedies HMA may have, if at any time the Client is in breach of any obligation (including those relating to payment) under these terms and conditions HMA may suspend or terminate the supply of Goods to the Client. HMA will not be liable to the Client for any loss or damage the Client suffers because HMA has exercised its rights under this clause.  
HMA may cancel any contract to which these terms and conditions apply or cancel delivery of Goods at any time before the Goods are delivered by giving written notice to the Client. On giving such notice HMA shall repay to the Client any money paid by the Client for the Goods. 19.8 HMA shall not be liable for any loss or damage whatsoever arising from such cancellation.  
Where the Client cancels delivery of the Goods, HMA reserves the right to charge the Client a cancellation fee. As a guide, the maximum charge as a percentage of the Price based on stock code shall be:  
(A) SC0 – 25%  
(B) SC1 – no fee  
(C) SC2 – 75%  
(D) SC3 – 50%  
(E) SC8 – 75%  
Cancellation of orders for special or SC9 Goods will definitely not be accepted, once HMA has processed the order.

**PRIVACY POLICY**  
All emails, documents, images or other recorded information held or used by HMA is Personal Information as defined and referred to in clause 15.3, and therefore considered Confidential Information. HMA acknowledges its obligation in relation to the handling, use, disclosure and processing of Personal Information pursuant to the Privacy Act 1988 ("the Act") including the Part III of the Act being Privacy Amendment (Notifiable Data Breaches) Act 2015 (NDP) and any statutory requirements, where relevant in a European Economic Area ("EEA"), under the EU Data Privacy Laws (including the General Data Protection Regulation ("GDPR") (collectively "EU Data Privacy Laws"). HMA acknowledges that in the event it becomes aware of any data breaches and/or disclosure of the Client's Personal Information to HMA for Services – that may or may not have previously been supplied – the Client in accordance with the Act and/or the GDPR. Any release of such Personal Information must be in accordance with the Act and the GDPR (where relevant) and must be approved by the Client by written consent, unless subject to an operation of law.  
Notwithstanding clause 15.1, privacy limitations will extend to HMA in respect of Cookies where transactions for purchases/orders transpire directly from HMA's website. HMA agrees to display reference to such Cookies and/or similar tracking technologies, such as pixels and web beacons (if applicable), such technology allows the collection of Personal Information such as the Client's:  
(a) IP address, browser, email client type and other similar details;  
(b) tracking website usage and traffic; and  
(c) reports are available to HMA when HMA sends an email to the Client, so HMA may collect and review that information ("Collectively Personal Information").  
In order to enable / disable the collection of Personal Information by way of Cookies, the Client shall have the right to enable / disable the Cookies first by selecting the option to enable / disable, provided on the website prior to proceeding with a purchase/order via HMA's website.  
The Client agrees for HMA to obtain from a credit reporting body (CRB) a credit report containing personal credit information (e.g. name, address, D.O.B, occupation, driver's license details, electronic contact (email, Facebook or Twitter details), medical insurance details) and in order to contact information (where applicable), previous credit applications, credit history) about the Client in relation to credit provided by HMA. The Client agrees that HMA may exchange information about the Client with those credit providers and with related body corporates for the following purposes:  
(a) to assess an application by the Client; and/or  
(b) to notify other credit providers of a default by the Client; and/or  
(c) to exchange information with other credit providers as to the status of this credit account, where the Client is in default with other credit providers; and/or  
(d) to assess the creditworthiness of the Client including the Client's repayment history in the preceding two (2) years.  
The Client consents to HMA being given a consumer credit report to collect overdue payment on commercial credit.  
The Client agrees that personal credit information provided may be used and retained by HMA for the following purposes (and for other agreed purposes or required by):  
(a) the provision of Goods; and/or  
(b) analysing, verifying and/or checking the Client's credit, payment and/or status in relation to the provision of Goods; and/or  
(c) processing of any payment instructions, direct debit facilities and/or credit facilities requested by the Client; and/or  
(d) enabling the collection of amounts outstanding in relation to the Goods.  
HMA may give information about the Client to a CRB for the following purposes:  
(a) to obtain a consumer credit report;  
(b) allow the CRB to create or maintain a credit information file about the Client including credit history.  
The information given to the CRB may include:  
(a) Personal Information as outlined in 15.3 above;  
(b) name of the credit provider and that HMA is a current credit provider to the Client;  
(c) whether the credit provider is a licensee;  
(d) type of consumer credit;  
(e) details concerning the Client's application for credit or commercial credit (e.g. date of commencement/termination of the credit account and the amount requested);  
(f) advice of consumer credit defaults, overdue accounts, loan repayments or outstanding monies which are overdue by more than sixty (60) days and for which written notice for request of payment has been made and debt recovery action commenced or alternatively that the Client no longer has any overdue accounts and HMA has been paid or otherwise discharged and all details surrounding that discharge (e.g. dates of payments);  
(g) information that, in the opinion of HMA, the Client has committed a serious credit infringement;  
(h) advice that the amount of the Client's overdue payment is equal to or more than one hundred and fifty dollars (\$150).  
The Client shall have the right to request (by e-mail) from HMA:  
(a) a copy of the Personal Information about the Client retained by HMA and the right to request that HMA correct any incorrect Personal Information; and  
(b) that HMA does not disclose any Personal Information about the Client for the purpose of direct marketing.  
HMA will destroy Personal Information upon the Client's request (by e-mail) or if it is no longer required unless it is required in order to fulfil the obligations of this Contract or is required to be maintained and/or stored in accordance with the law.  
The Client can make a privacy complaint by contacting HMA via e-mail. HMA will respond to that complaint within seven (7) days of receipt and will take all reasonable steps to make a decision as to the complaint within thirty (30) days of receipt of the complaint. In the event that the Client is not satisfied with the resolution provided, the Client can make a complaint to the Information Commissioner at [www.oaic.gov.au](http://www.oaic.gov.au).  
**BUILDING AND CONSTRUCTION INDUSTRY SECURITY OF PAYMENTS ACT 1999**  
At HMA's sole discretion, if there are any disputes or claims for unpaid Goods and/or Services then the provisions of the Building and Construction Industry Security of Payments Act 1999 may apply.  
Nothing in this Contract is intended to have the effect of contracting out of any applicable provisions of the Building and Construction Industry Security of Payments Act 1999 of New South Wales, except to the extent permitted by the Act where applicable.  
**SERVICE OF NOTICES**  
Any written notice given under this Contract shall be deemed to have been given and received:  
(a) by handing the notice to the other party, in person;  
(b) by leaving it at the address of the other party as stated in this Contract;  
(c) by sending it by registered post to the address of the other party as stated in this Contract;  
(d) if sent by facsimile transmission to the fax number of the other party as stated in this Contract (if any), on receipt of confirmation of the transmission;  
(e) if sent by email to the other party's last known email address.  
Notwithstanding anything contained in this clause it shall be deemed to have been served, at the time when by the ordinary course of post, the notice would have been delivered.  
**TRUSTS**  
18.1 If the Client at any time upon or subsequent to entering in to the Contract is acting in the capacity of trustee of any trust ("Trust") then whether or not HMA may have notice of the Trust, the Client covenants with HMA as follows:  
(a) the Client consents to all rights of indemnity which the Client now or subsequently may have in respect of the Trust and the trust fund;  
(b) the Client has full and complete power and authority under the Trust to enter into the Contract and the provisions of the Trust do not purport to exclude or take away the right of indemnity of the Client against the Trust or the trust fund. The Client will not release the right of indemnity or commit any breach of trust or be a party to any other action which might prejudice that right of indemnity;  
(c) the Client will not without consent in writing of HMA (HMA will not unreasonably withhold consent), cause, permit, or suffer to happen any of the following events;  
(i) the removal, replacement or retirement of the Client as trustee of the Trust;  
(ii) any alteration to or variation of the terms of the Trust;  
(iii) any advancement or distribution of capital of the Trust; or  
(iv) any resettlement of the trust property.  
**GENERAL**  
The failure by either party to enforce any provision of these terms and conditions shall not be treated as a waiver of that provision, nor shall it affect that party's right to subsequently enforce that provision. If any provision of these terms and conditions shall be invalid, void, illegal or unenforceable the validity, existence, legality and enforceability of the remaining provisions shall not be affected, prejudiced or impaired.  
These terms and conditions and any contract to which they apply shall be governed by the laws of New South Wales, the state in which HMA has its principal place of business, and are subject to the jurisdiction of the courts in that New South Wales.  
Subject to clause 11 HMA shall be under no liability whatsoever to the Client for any indirect and/or consequential loss and/or expense (including loss of profit) suffered by the Client arising out of a breach by HMA of these terms and conditions (alternatively HMA's liability shall be limited to damages which under no circumstances shall exceed the Price of the Goods).  
HMA may licence and/or assign all or any part of its rights and/or obligations under this Contract without the Client's consent.  
The Client cannot licence or assign without the written approval of HMA.  
HMA may elect to subcontract out any part of the Services but shall not be relieved from any liability or obligation under this Contract by so doing. Furthermore, the Client agrees and understands that they have no authority to give any instruction to any of HMA's sub-contractors without the authority of HMA.  
The Client agrees that HMA may amend their general terms and conditions for subsequent future contracts with the Client by disclosing such to the Client in writing. These changes shall be deemed to take effect from the date on which the Client accepts such changes, or otherwise at such time as the Client makes a further request for HMA to provide Goods to the Client.  
Neither party shall be liable for any default due to any act of God, war, terrorism, strike, lock-out, industrial action, fire, flood, storm or other event beyond the reasonable control of either party.  
Both parties warrant that they have the power to enter into this Contract and have obtained all necessary authorisations to allow them to do so, they are not insolvent and that this Contract creates binding and valid legal obligations on them.





**Hard Metals Australia Pty Ltd**

40 Peter Brock Drive  
Eastern Creek NSW 2766  
Australia

Ph: 02 9009 4455  
Email: [sales@hardmetals.com](mailto:sales@hardmetals.com)

**Hardmetals Canada Inc**

Unit 6, 9550 114 Ave  
Calgary Alberta T35-OA5

Ph: +1 403 615 6163  
Email: [canada@hardmetals.com](mailto:canada@hardmetals.com)

