

HARDMETALS

UPDATED

CONSTRUCTION

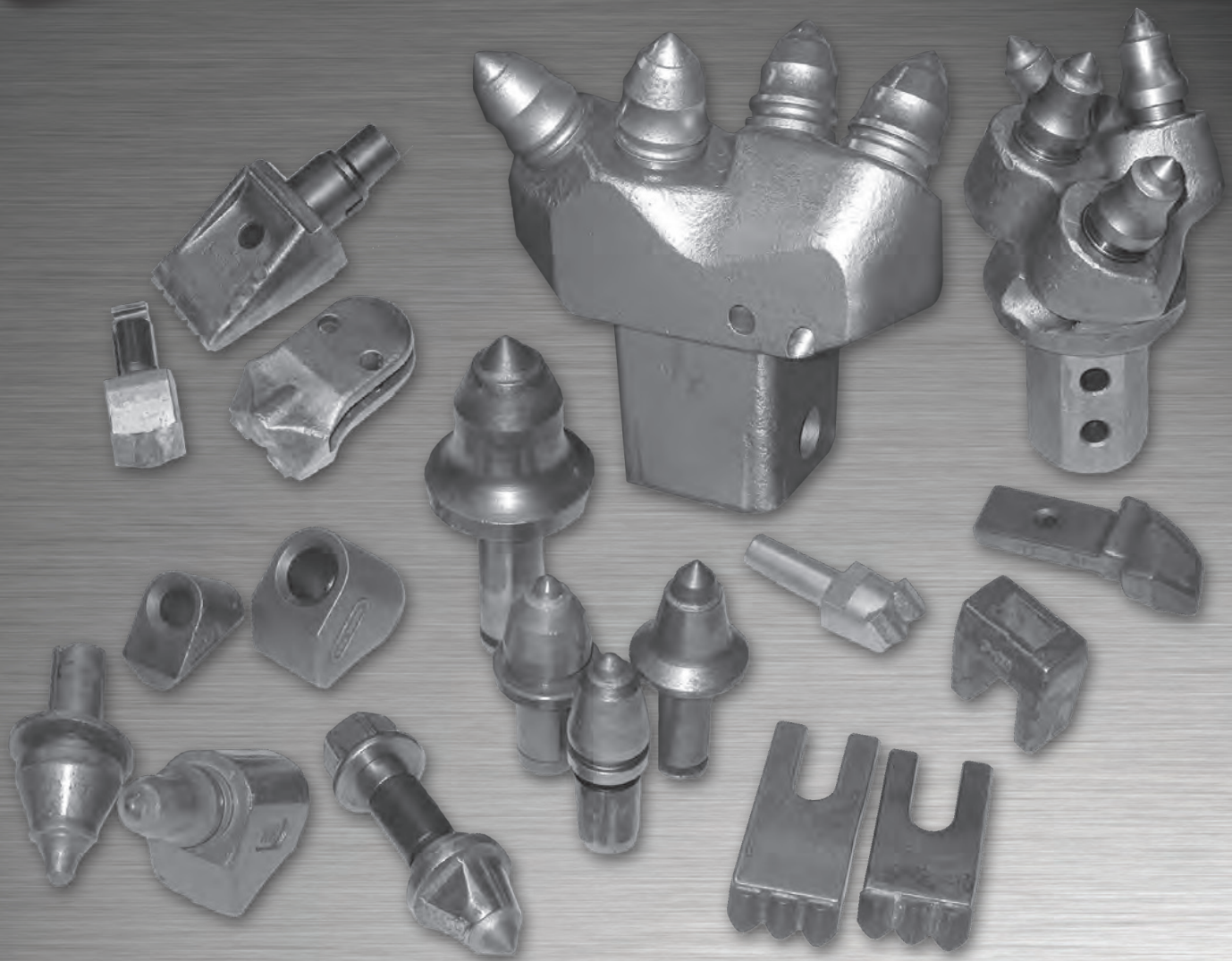

PROUDLY AUSTRALIAN OWNED



CONTENTS

Company Overview	1
Trenching & Construction Tools	2
Stock Code System	3
Conical Picks Inserts.....	4
Conical Pick C Blocks	6
Conical Pick B Blocks	8
Conical Pick Sleeve Holder	9
Conical Extraction Tools	10
Conical Picks	12
Conical Pick -55	12
Conical Pick- 74	12
Conical Pick- 76	13
Conical Pick- 86	15
Conical Pick -99	16
Conical Pick -116	17
Conical Pick -118	18
Foundation Drilling Tools.....	19
Drilling Tools.....	20
Wear Protection Weld On Teeth.....	21
EMF Flat Auger Teeth.....	22
EMF Fishtail & Auger Part.....	25
Flat Cutter Picks & Blocks	26
Taper Fit Auger Teeth	27
Taper Holders	28
1 ¼" BSW Centre Bits.....	29
1 ¾" AF HEX Centre Bits	30
1 ¾" AF & 2 ½" Hex Centre Bits	32
EM Holders.....	33
Drive Pin Location Bush	34
Proline Tools.....	34

COMPANY OVERVIEW

Hard Metals Australia Pty Limited (HMA) is a precision engineering company specialising in the design and manufacture of Tungsten Carbide and Polycrystalline diamond tools for the drilling, construction, mining and agricultural industries. Formed in 1982 as Australasian distributor for a world leading Tungsten Carbide Manufacture, HMA was instrumental in the development and application of Tungsten Carbide for agricultural ground engaging tools during the 80's and early 90's. Since then our range of products have significantly increased.

HMA now manufactures tungsten carbide tools for the following Industries

- Mining and Exploration
- Foundation and Piling Drilling Tools.
- Trenching and Road Profiling Tools
- Horizontal Directional Drilling
- Agricultural Tillage Tools
- Forestry and Recycling Industry Tools
- Special or Custom Designed Wear Parts

*TRENCHING &
CONSTRUCTION
TOOLS*



CP CONSTRUCTION TOOLS

The range covers the following series/shank sizes

- 0.55" – 14.0mm shanks
- 0.74" – 18.8mm shanks
- 0.76" – 19.3mm shanks
- 0.86" – 21.8mm shanks
- 0.99" – 25.0mm shanks
- 1.16" – 29.5mm stepped shanks
- 1.18" – 30mm straight shanks

Associated products include holders and pick removing tools. These tools provide a very economical and durable solution for many tooling applications.

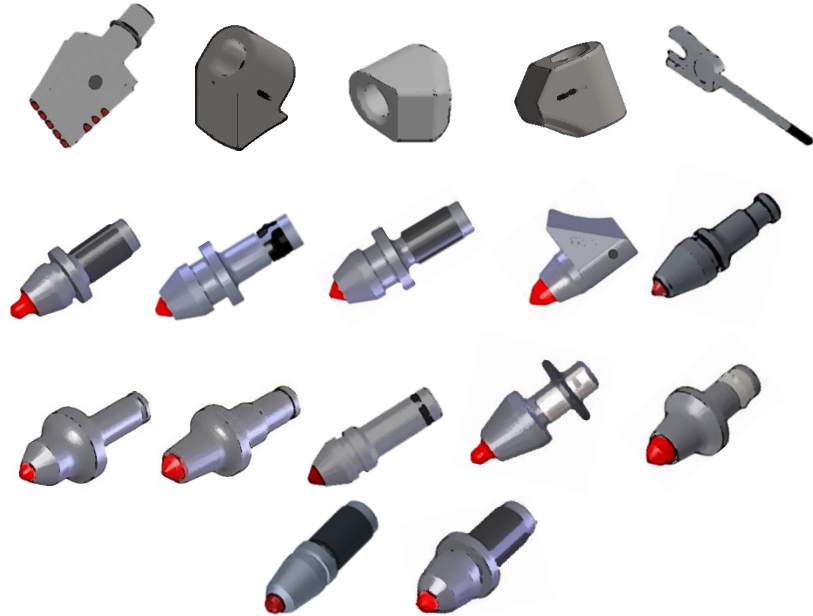



STOCK CODE SYSTEM

STOCK CODE	DESCRIPTION
0	Phase out item / Not to be replaced / Upgraded
1	Standard Stock Item / Min Stock is required to be kept on hand
3	Irregular Stock Item / Minimum order quantity may be required
6	New Stock Item / Stock code undefined
8	Non Stock Item / Minimum quantity required

CONICAL PICK INSERTS

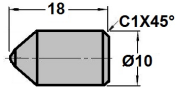
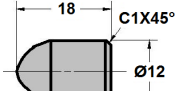
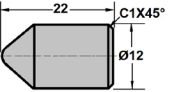
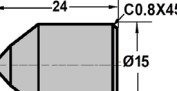
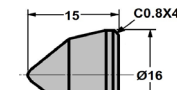
CONICAL PICK INSERTS

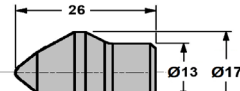
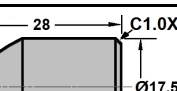
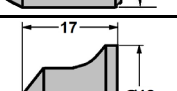
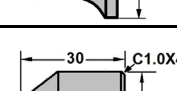
Part Number	Drawing
TBB-10SCI	
TBB-12DCI	
TBB-12SCI	
TBB-15DC1	
TBB-16DCC	
TBB-16CI	
TBB-17MI	
TBB-17.5SCI	
TBB-18BC	
TBB-19SCI	





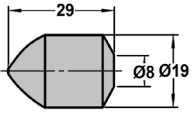
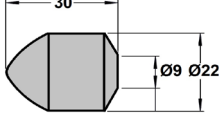
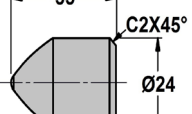
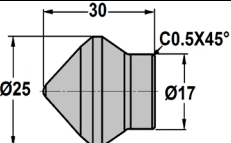



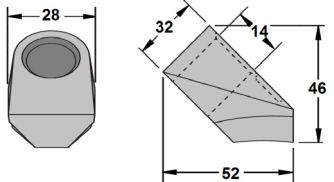

CONICAL PICKS INSERTS

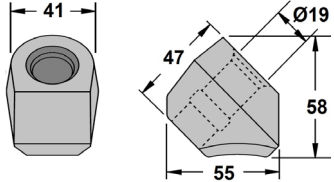
CONICAL PICK INSERTS

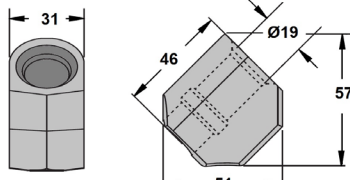

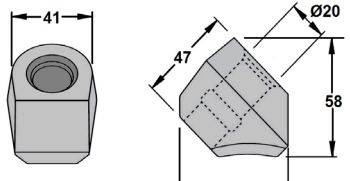

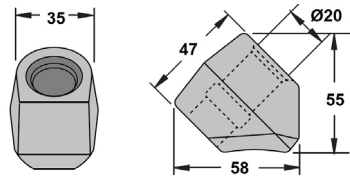

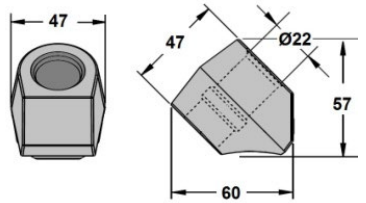



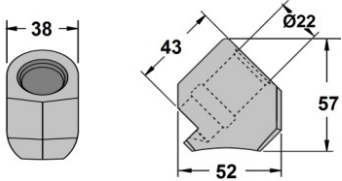

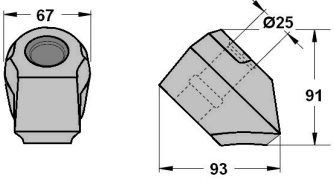
Part Number	Drawing
TBB-19BI	
TBB-22BI	
TBB-24BI	
TBB-25MI	

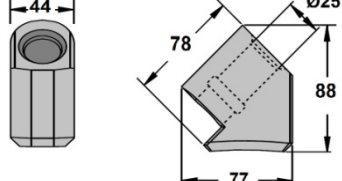
C BLOCKS

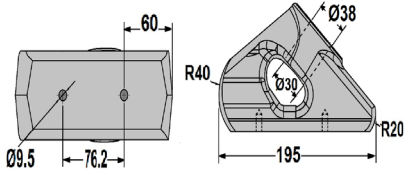
CONICAL PICK C BLOCKS

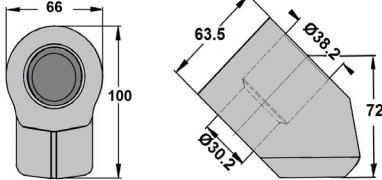
Part Number	Stock Code	Description	Drawing
C-055	1	Conical Pick Block Normal Duty 55 Series 	
C-1	3	Conical Pick Block Normal Duty 74 Series 	
C-1S	1	Conical Pick Block Slim Line 74 Series 	
C-2	1	Conical Pick Block Heavy Duty 76 Series 	
C-2S	0	Conical Pick Block Slim Line 76 Series 	
C-3	1	Conical Pick Block Heavy Duty 86 Series 	

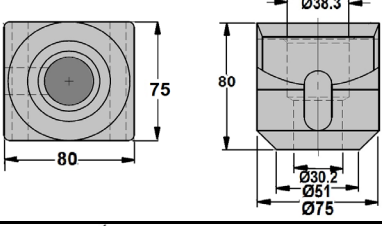

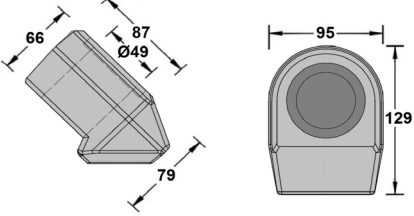







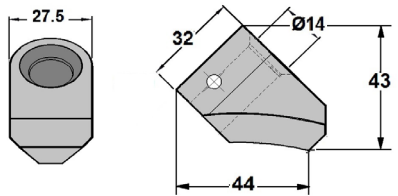

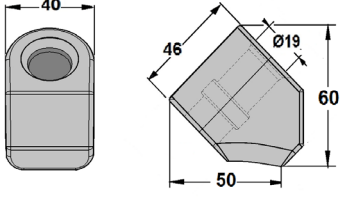
CONICAL PICK C BLOCKS

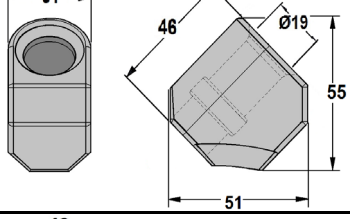
Part Number	Stock Code	Description	Drawing
C-3S	0	Conical Pick Block Slim Line 86 Series 	
C-4	1	Conical Pick Block Heavy Duty 99 Series 	
C-4S	1	Conical Pick Block Slim Line 99 Series 	
C-6BHD	1	Conical Pick Block Heavy Duty Stepped Bush 116 Series NEW 	
C-6S	1	Conical Pick Block Normal Duty 116 Series 	
C-6F	1	Holder For CPF70 	
C-9BHD	3	Heavy Duty Bush Block Series 150 NEW 	

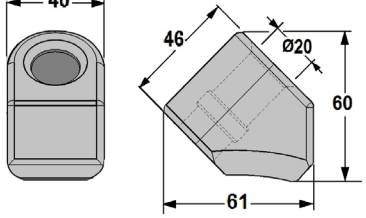
B BLOCKS

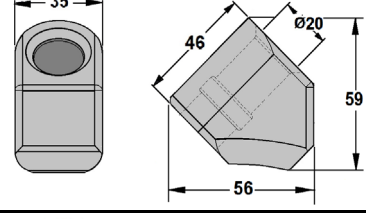
CONICAL PICK B BLOCKS

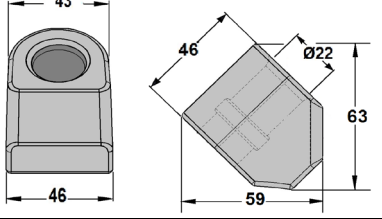

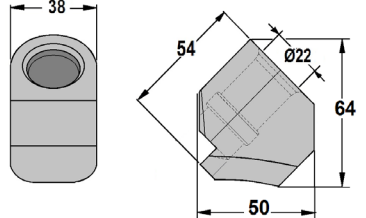



New Improved Geometry

Part Number	Stock Code	Description	Drawing
B-055	6	Conical Pick Block Normal Duty 55 Series NEW 	
B-1	6	Conical Pick Block Normal Duty 74 Series NEW 	
B-1S	6	Conical Pick Block Slim Line 74 Series NEW 	
B-2	6	Conical Pick Block Heavy Duty 76 Series NEW 	
B-2S	1	Conical Pick Block Slim Line 76 Series NEW 	
B-3	6	Conical Pick Block Heavy Duty 86 Series NEW 	
B-3S	1	Conical Pick Block Slim Line 86 Series NEW 	

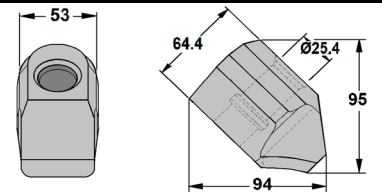

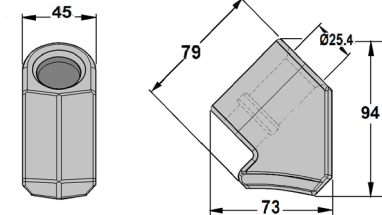

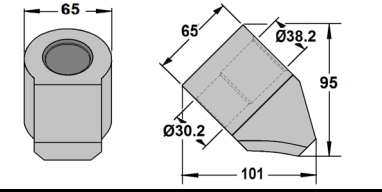
B BLOCKS & SLEEVE HOLDERS

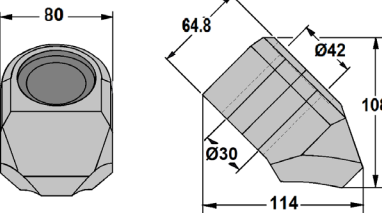
CONICAL PICK B BLOCKS

New Improved Geometry

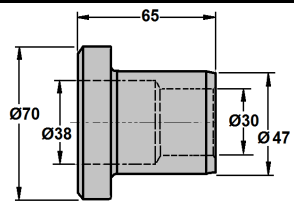
Part Number	Stock Code	Description	Drawing
B-4	6	Conical Pick Block Heavy Duty 99 Series NEW 	
B-4S	6	Conical Pick Block Slim Line 99 Series NEW 	
B-6S	6	Conical Pick Block Normal Duty 116 Series NEW 	
B-7B	1	Conical Pick Block Heavy Duty Hardened Sleeved 118 Series NEW 	

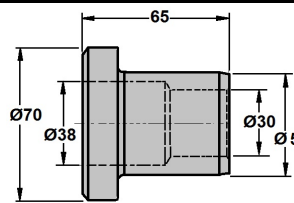
CONICAL PICK SLEEVE HOLDER

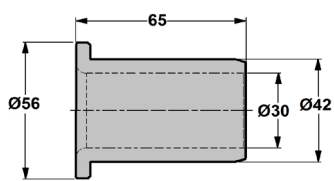
Part Number	Stock Code	Description	Drawing
SL-6	1	Sleeve for CP116 	
SL-6A	1	Sleeve for CP116 Fits C-6BHD NEW 	
SL-7	1	Sleeve for CP118 	

EXTRACTION TOOLS

CONICAL EXTRACTION TOOLS

Part Number	Stock Code	Description	Drawing
CP-12P2	1	Conical Pick Extraction Punch Suit 74/ 76/86/ 99 Series Pick	
CP-12P3	1	Conical Pick Extraction Punch Suit 74/ 76/86/ 99 Series Pick	
CP-12T	1	Conical Pick Extraction Tool Suit 74/ 76 Series Picks	
CP-12RP	1	Conical Pick Extraction Tool Suit 86 Series Picks	
CP-14T	1	Conical Pick Extraction Tool Suit 99 Series Picks	
CP-16T	1	Series 116 Pick Remover	

EXTRACTION TOOLS

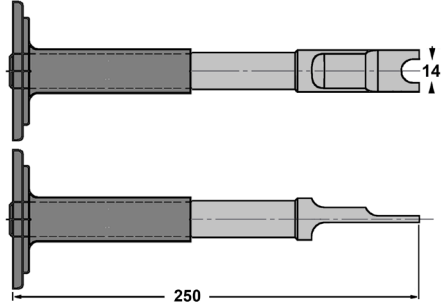
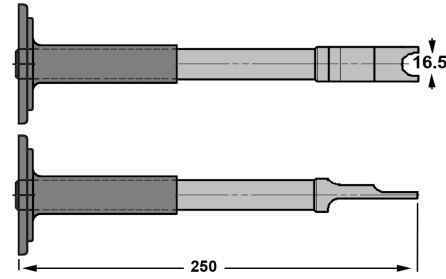
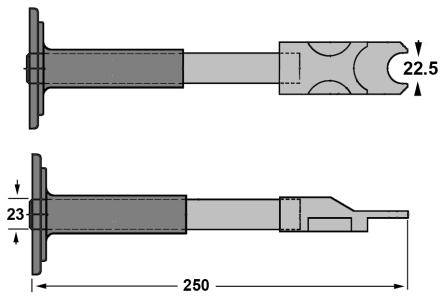
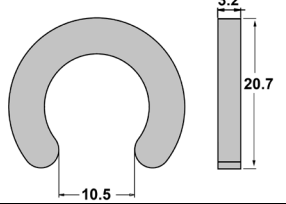
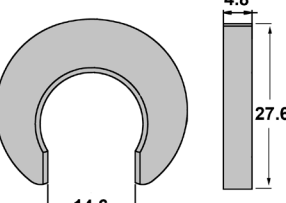
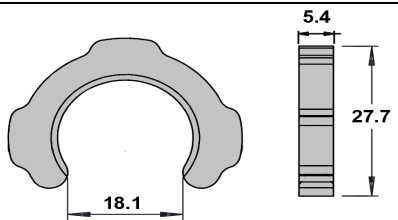

CONICAL EXTRACTION TOOLS

Part Number	Stock Code	Description	Drawing
CP-12CR	1	Conical Pick Clip Remover Suit 76 Series Picks NEW	
CP-13CR	1	Conical Pick Clip Remover Suit 86/ 99 Series Picks NEW	
CP-16CR	1	Conical Pick Clip Remover Suit 116/ 118 Series Picks NEW	
SC-076	1	Retaining Clip 76 series	
SC-099	1	Retaining Clip 086/099 series	
SC-118	1	Retaining Clip 116/118 series	

55 SERIES

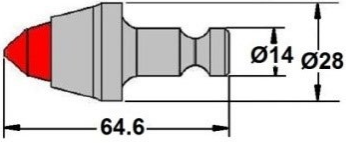

CONICAL PICKS

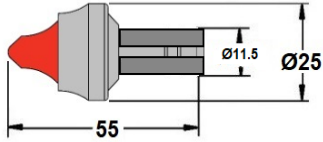
CONICAL PICK - 55





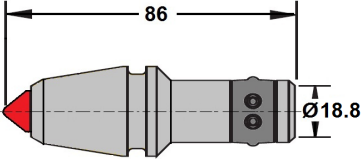

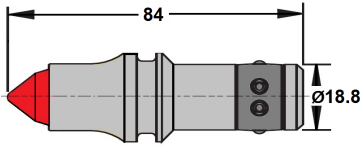



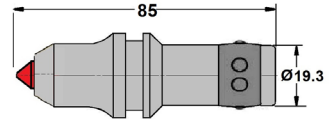

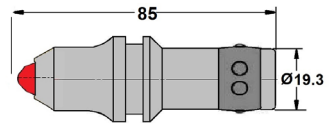

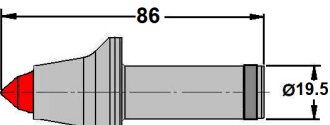
Part Number	Stock Code	Description	Drawing
<p>CP01 (CP055FB-16DCC-RPR)</p>	1	<p>Conical- 55 Series Full Body 16mm Cone Cap</p> 	
<p>CP02 (CP055FB-16BC-LR)</p>	1	<p>Conical- 55 Series Full Body 16mm Bell Cap</p> 	

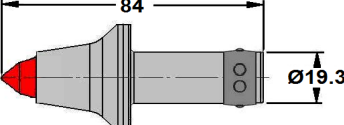
74 SERIES

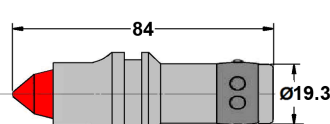
CONICAL PICK- 74

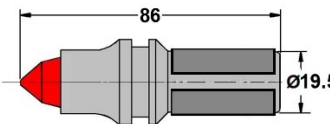

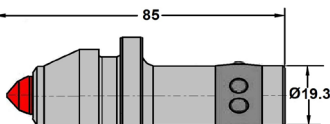

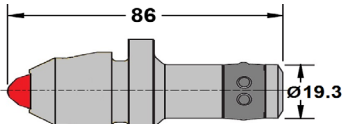

Part Number	Stock Code	Description	Drawing
<p>CP10 (CP074GNB-12SCI-SR)</p>	1	<p>Conical- 74 Series Grooved/Narrow Body 12mm S/Cone Insert</p> 	
<p>CP13 (CP074GNB-16DCC-SR)</p>	1	<p>Conical- 74 Series Grooved/Narrow Body 16mm D/Cone Cap</p> 	

CONICAL PICK- 76

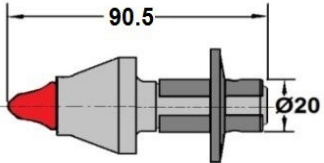

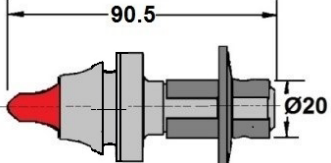

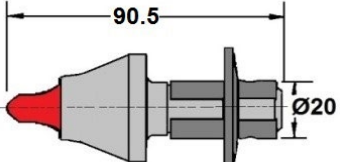

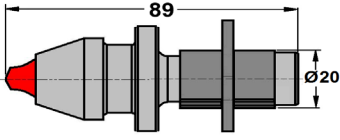

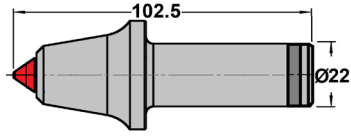

Part Number	Stock Code	Description	Drawing
CP20A (CP076GNB-12SCI-SR)	1	Conical- 76 Series Grooved Narrow Body 12mm S/Cone Insert 	
CP20B (CP076GNB-12DCI-SR)	1	Conical- 76 Series Grooved Narrow Body 12mm Cone Insert 	
CP21 (CP076FB-16DCC-CR)	1	Conical- 76 Series Full Body 16mm D/Cone Cap 	
CP22 (CP076FB-16DCC-SR)	1	Conical- 76 Series Full Body 16mm D/Cone Cap 	
CP23 (CP076GNB-16DCC-SR)	1	Conical- 76 Series Grooved Narrow Body 16mm D/Cone Cap 	
CP23L (CP076GNB-16DCC-LR)	1	Conical- 76 Series Grooved Narrow Body 16mm D/Cone Cap NEW 	
CP24 (CP076GFB-16DCC-SR)	1	Conical- 76 Series Full Body 16mm D/Cone Cap 	
CP25 (CP076GFB-12DCI-SR)	1	Conical- 76 Series Grooved Flanged Body 12mm Cone Insert 	

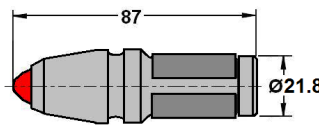
76 SERIES

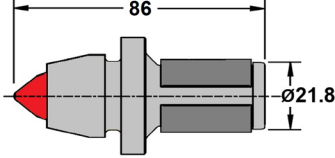
CONICAL PICK- 76

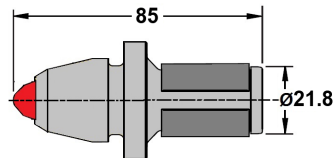

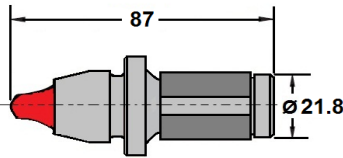

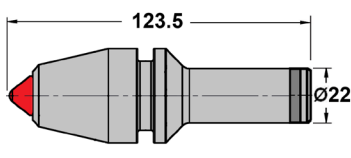



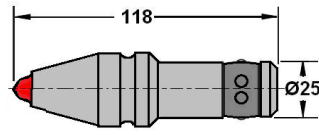

Part Number	Stock Code	Description	Drawing
<p>CP26W (CP076FB-19KBC-LRW)</p>	3	<p>Conical- 76 Series Full Body 19mm Bell Cap</p> 	
<p>CP27W (CP076GFB-18BC-LRW)</p>	1	<p>Conical- 76 Series Grooved Flanged Body 18mm Bell Cap</p> 	
<p>CP28W (CP076FB-18BC-LRW)</p>	1	<p>Conical- 76 Series Full Body 18mm Bell Cap</p> 	
<p>CP29W (CP076GFB-16BC-LRW)</p>	3	<p>Conical- 76 Series Full Body 16mm Bell Cap</p> 	

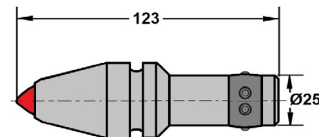
CONICAL PICK- 86

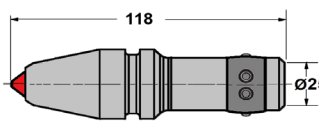

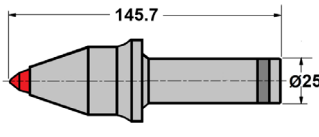

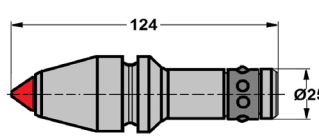

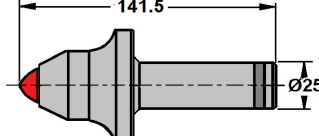



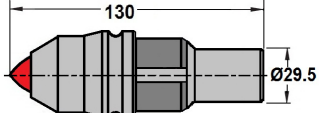

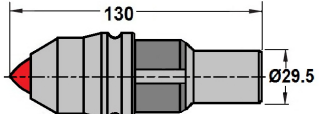
Part Number	Stock Code	Description	Drawing
CP30A (CP086FGB-12CI-CR)	1	Conical – 86 Series Full Body 12mm Cone Insert NEW 	
CP30B (CP086GNB-12DCI-LR)	1	Conical- 86 Series Grooved Narrow Body 12mm Cone Insert 	
CP34L (CP086GFB-16DCC-LR)	1	Conical- 86 Series Flanged Head Body 16mm D/Cone Cap NEW 	
CP35L (CP086GFB-12DCI-LR)	1	Conical- 86 Series Flanged Head Body 12mm Cone Insert 	
CP37L (CP086GFB-18BC-LR)	1	Conical- 86 Series Flanged Head Body 18mm Bell Cap 	
CP39 (CP086GNB-16CI-CR)	1	Conical -86 Series Grooved Narrow Body 16mm Cone Insert NEW 	

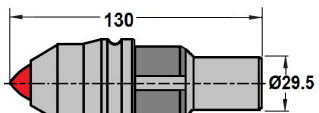
99 SERIES

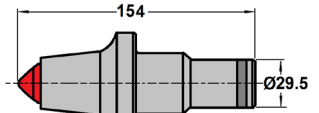
CONICAL PICK- 99

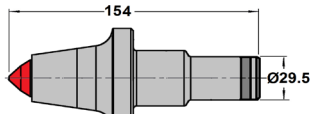

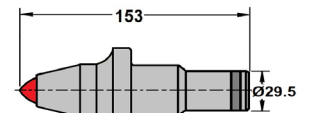

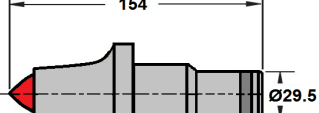





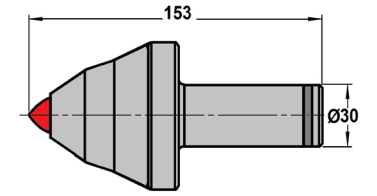

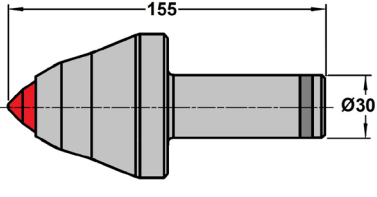
Part Number	Stock Code	Description	Drawing
CP41 (CP099GNB-12DCI-SR)	1	Conical- 99 Series Grooved Narrow Body 12mm Cone Insert 	
CP42 (CP099GNB-16CI-SR)	1	Conical- 99 Series Grooved Narrow Body 16mm Cone Insert 	
CP43 (CP099GNB-12SCI-SR)	1	Conical- 99 Series Grooved Slim Body 12mm S/Cone Insert NEW 	
CP44 (CP099FB-16DCC-CR)	8	Conical- 99 Series Full Body 16mm D/Cone Cap 	
CP45 (CP099GNB-17.5CI-SR)	1	Conical- 99 Series Full Body 17.5mm Cone Insert NEW 	
CP46 (CP099FB-19BI-CR)	1	Conical- 99 Series Full Body 19mm Ballistic Insert 	

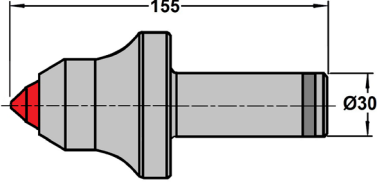
CONICAL PICK- 116

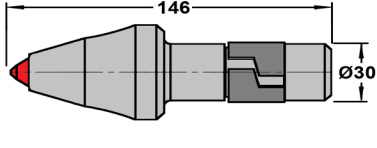
Part Number	Stock Code	Description	Drawing
CP60 (CP116GNB-22BI-MR)	1	Conical- 116 Series Stepped Shank Grooved Narrow Body 22mm Ballistic Insert 	
CP60B (CP116GNB-17.5BI-MR)	1	Conical- 116 Series Stepped Shank Grooved Narrow Body 17.5mm Ballistic Insert NEW 	
CP60C (CP116GNB-19BI-MR)	1	Conical- 116 Series Stepped Shank Grooved Narrow Body 19mm Ballistic Insert NEW 	
CP61C (CP116FB-25MI-CR)	0	Conical- 116 Series Stepped Shank Full Body 63.5mm 25mm Mushroom Insert 	
CP61D (CP116FB-25MI-CR)	1	Conical – 116 Series Stepped Shank Large Flanged Body 68mm 25mm Mushroom Insert NEW 	
CP62 (CP116FB-22BI-CR)	3	Conical- 116 Series Stepped Shank Full Body 22mm Ballistic Insert 	
CP63 (CP116FB-25BI-CR)	8	Conical – 116 Series Stepped Shank Full Body 25mm Ballistic Insert 	

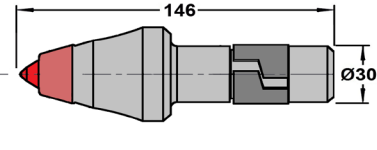
118 SERIES

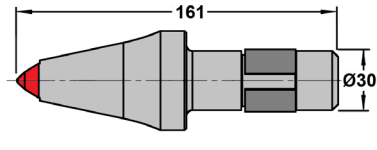
CONICAL PICK- 118

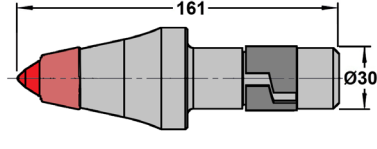







Part Number	Stock Code	Description	Drawing
CP70 (CP118FB-17SCI-CR)	3	Conical- 118 Series Straight Shank Full Body 17mm S/Cone Insert 	
CP71 (CP118FB-22BI-CR)	1	Conical- 118 Series Straight Shank Full Body 22mm Ballistic Insert 	
CP72C (CP118FB-25MI-CR)	1	Conical- 118 Series Straight Shank Full Body 25mm Mushroom Insert 	
CP74 (CP118FB-15DCI LRC)	3	Conical – 118 Series Straight Shank Mid retainer 15mm Cone Insert NEW 	
CP74HF (CP118FB-15DCI LRC)	3	Conical – 118 Series Straight Shank Mid Retainer 15mm Cone Insert Hard Faced NEW 	
CP75 (CP118FB-17MI-LRC)	3	Conical – 118 Series Straight Shank Mid Retainer 17mm Mushroom Insert NEW 	
CP75HF (CP118FB-17MI-LRC)	3	Conical – 118 Series Straight Shank Mid Retainer 17mm Mushroom Insert Hard Faced NEW 	

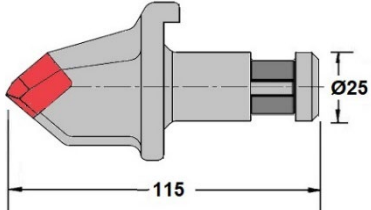

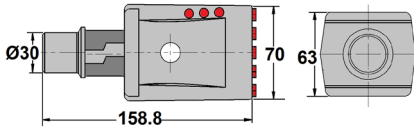

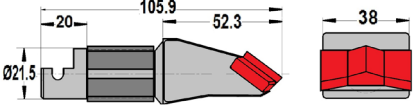

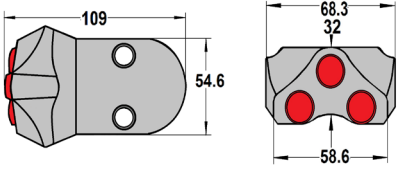

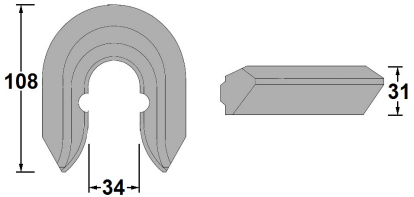
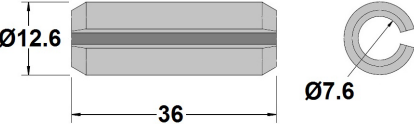



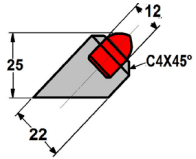

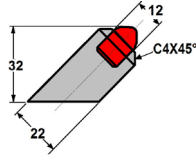

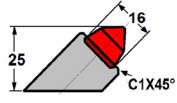

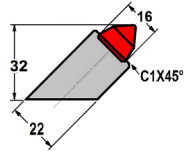
*FOUNDATION
DRILLING
TOOLS*

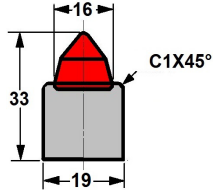
DRILLING TOOLS

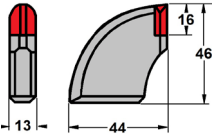
FOUNDATION DRILLING TOOLS

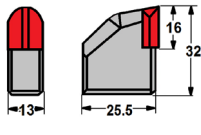

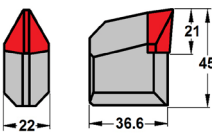

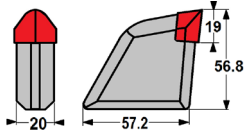





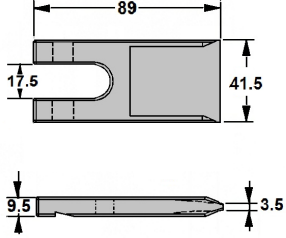

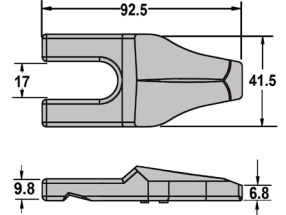
Part Number	Stock Code	Description	Drawing
CPF08	1	Taper Pick Dragon Tooth	
CPF70	1	Flat Pick Fits Holder C-6F 	
CPF150	1	Flat Pick Fits Holder C-3S and B-3S 	
QCB39	1	Quick Change Bar with Carbide Inserts NEW 	
QCB39H	1	Quick Change Bar Holder NEW 	
QCB39P	1	Pins for QCB39	

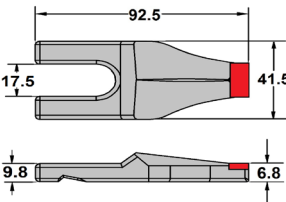
WEAR PROTECTION WELD ON TEETH

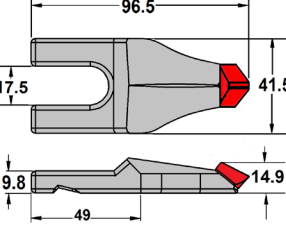
Part Number	Stock Code	Description	Drawing
HDD-12DCI-25-45	1	Weld On 12mm Insert Tooth Height 25mm 	
HDD-12DCI-32-45	1	Weld On 12mm Insert Tooth Height 32mm 	
HDD-16DCC-25-45	1	Weld On 16mm Cap Tooth Height 25mm 	
HDD-16DCC-32-45	1	Weld On 16mm Cap Tooth Height 32mm 	
HDD-16DCC-33-90	1	Weld On 16mm Cap Height 33mm Angle=90 	
EM405	1	Weld-On Tooth Height 44mm 	
EM405-S	1	Weld-On Tooth Height 25.5mm 	
EM405-22	1	Weld-On Tooth Height 36.5mm 	
EM405-22L	1	Weld-On Tooth Height 57mm 	

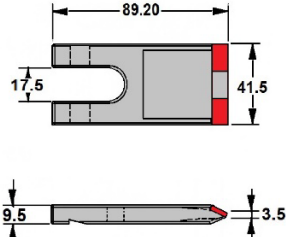

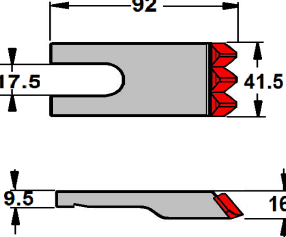

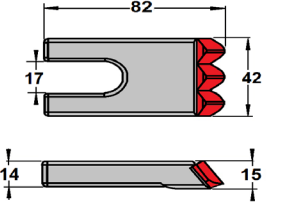

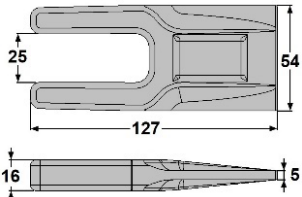

EMF FLAT AUGER TEETH

EMF FLAT AUGER TEETH

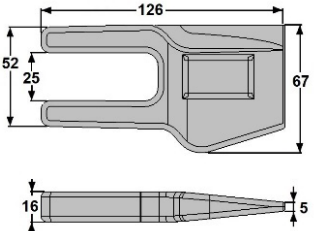
Part Number	Stock Code	Description	Drawing
EMF505	1	35 Series Plain Dirt Tooth 	
EMF506	1	Series 35 Plain Chisel Tooth 	
EMF508	1	35 Series Chisel Tooth Carbide Tipped 	
EMF509	1	35 Series Chisel Tooth Carbide Tipped FW Insert 	
EMF527	1	35 Series Flat Tooth Carbide Tipped 	
EMF535	1	35 Series Heavy Duty Triple Teeth Carbide Tipped 	
EMF535-14	1	35 Series Heavy Duty Triple Teeth Carbide Tipped 	

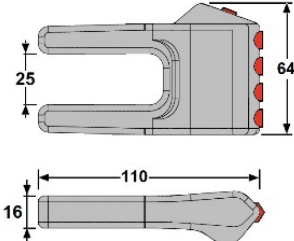

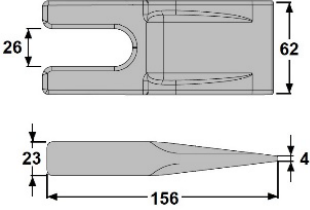

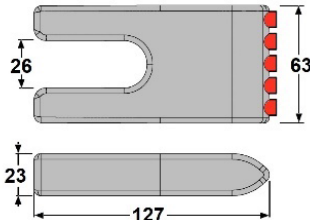

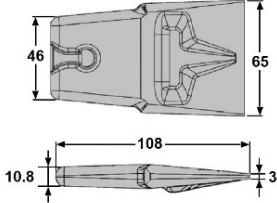

EMP FLAT AUGER TEETH

EMP FLAT AUGER TEETH

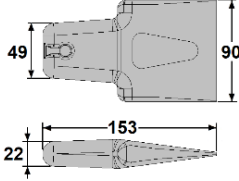
Part Number	Stock Code	Description	Drawing
EMP1650	3	For regular dirt conditions 	
EMP1652	3	Gage tooth for regular conditions 	
EMP1658	3	Carbide gage tooth for hard conditions 	
EMP2070	3	For regular dirt conditions 	
EMP2077	3	Carbide tooth for hard conditions 	

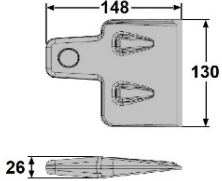

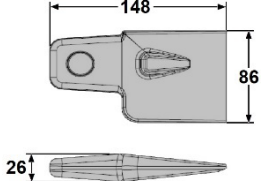

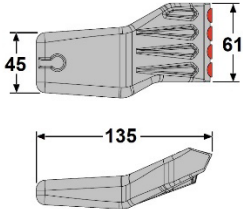





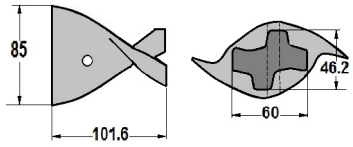

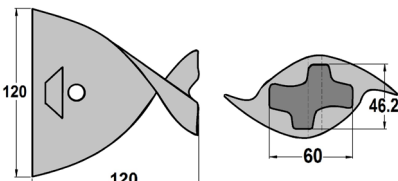
EMF FLAT AUGER TEETH

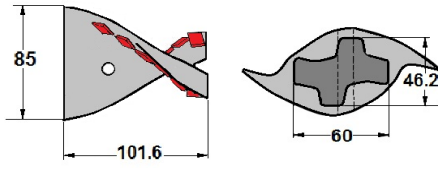
EMF FLAT AUGER TEETH

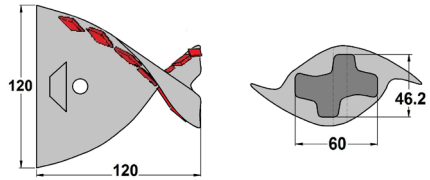
Part Number	Stock Code	Description	Drawing
EMP60 (EMP410WH)	3	For regular dirt conditions 	
EMP132 (EMP406WH)	3	For regular dirt conditions 	
EMP134	3	For regular dirt conditions. Double offset 	
EMP211	3	For hard conditions. Single offset 	
EMP299	3	Carbide tooth for hard conditions 	

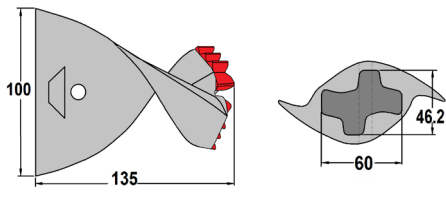

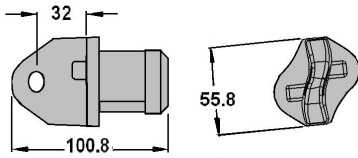

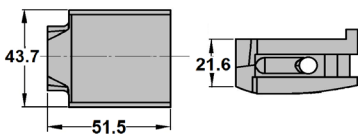

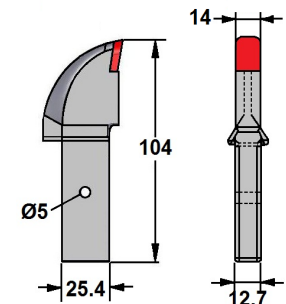

EMF FISHTAIL & AUGER PARTS

EMF FISHTAIL & AUGER PARTS

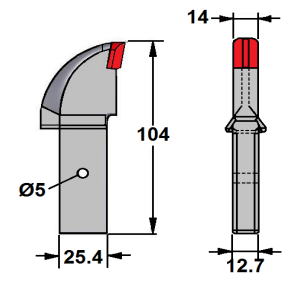
Part Number	Stock Code	Description	Drawing
EMF580	1	SB35 Plain Fish Tail Pilot 	
EMF590	1	SB45 Plain Fishtail Pilot 	
EMF610	1	SB35 TC Fish Tail Pilot Carbide Tipped 	
EMF611	3	SB45 TC Fish Tail Pilot Carbide Tipped 	
EMF612	1	SB35 HD TC Fish Tail Pilot Carbide Tipped Heavy Duty 	
EMF635	0	SB35 Weld On Drive Lug 	
EMF660	1	35 Series T36 Tooth Holder 	

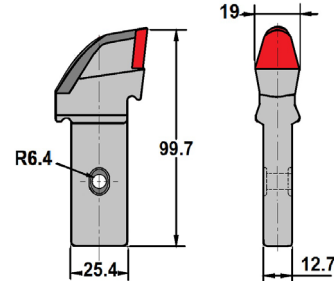

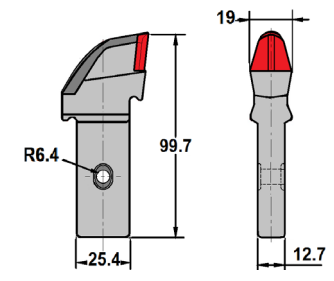

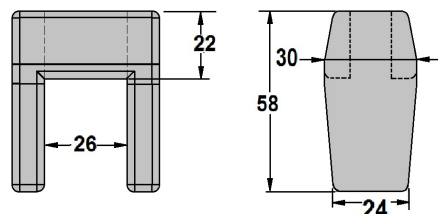





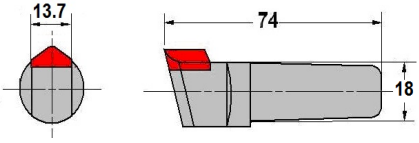

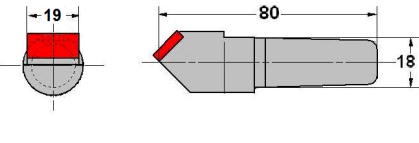

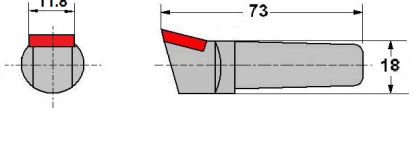
FLAT CUTTERS & BLOCKS

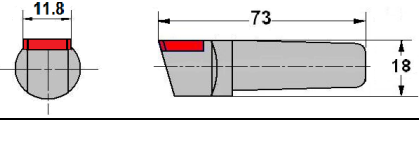
FLAT CUTTER PICKS & BLOCKS

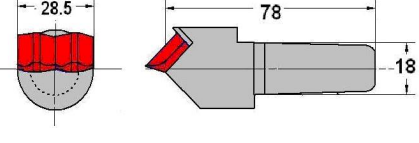

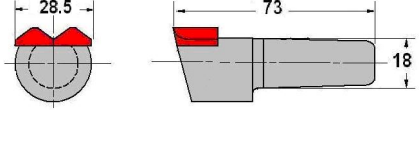

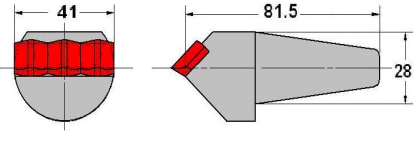
Part Number	Stock Code	Description	Drawing
EM410-F	1	Flat Cutter Pick 14mm Insert 	
EM410-P	1	Flat Cutter Pick 14mm Insert (FW8B) 	
EM411-F	1	Flat Cutter Pick 19mm Insert NEW 	
EM411-P	1	Flat Cutter Pick 19mm Insert NEW 	
F-2S	1	Flat Cutter Pick Block Forged NEW 	

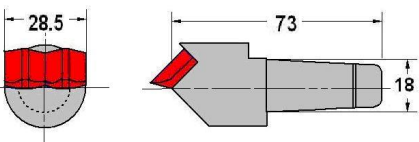
AUGER TEETH

TAPER FIT AUGER TEETH









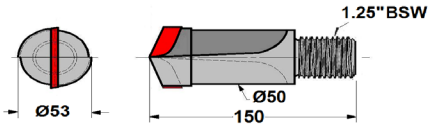

Part Number	Stock Code	Description	Drawing
EM4	1	Auger Bit 90 Degrees Rock Tooth 	
EM5	8	Auger Bit 45 Degrees Earth Tooth 	
EM6	8	Auger Bit Shale Tooth 	
EM6N	8	Auger Bit Neutral Rake Shale Tooth 	
EM20	1	Auger Bit 45 Degrees Double Teeth 	
EM21	1	Auger Bit 90 Degrees Double Teeth 	
EM24	1	Rock Auger Bit 45 Degrees Triple Teeth 	
EM25	8	Auger Bit 45 Degrees Double Teeth Small Taper 	

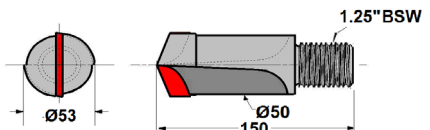
TAPER HOLDERS

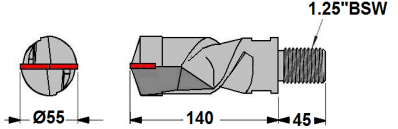

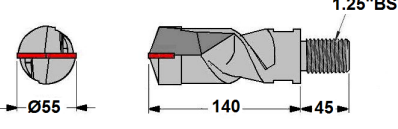

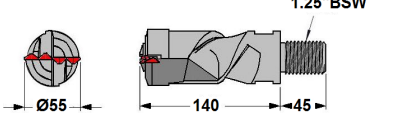

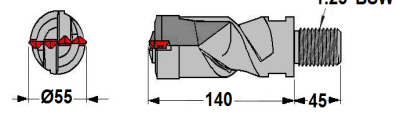

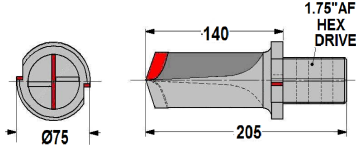

Part Number	Stock Code	Description	Drawing
EM37	8	MT2 Holder North, South 	
EM38	1	MT2 Holder East, West 	
EM58	1	MT2 Holder North, South East, West 	
EM39	1	EM24 Holder 	

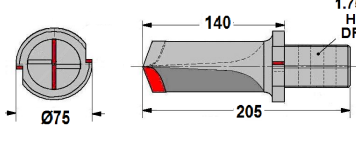
CENTRE BITS

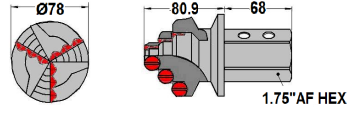
1 1/4" BSW CENTRE BITS

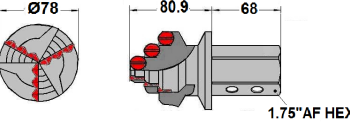

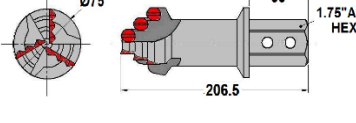

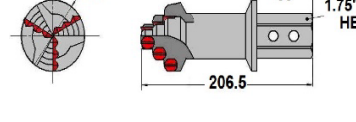



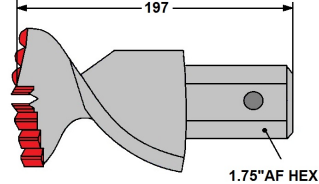

Part Number	Stock Code	Description	Drawing
EM8L-HD	3	Centre Bit Left Hand Heavy Duty 100mm Reach 	
EM8R-HD	1	Centre Bit Right Hand Heavy Duty 100mm Reach 	
EM8AL-S	1	Centre Bit Left Hand Spiral Flute 140mm Reach 	
EM8AR-S	1	Centre Bit Right Hand Spiral Flute 140mm Reach 	
EM8AL-SF	8	Centre Bit, Left Hand Spiral Flute MF style 140mm Reach 	
EM8AR-SF	8	Centre Bit Right Hand Spiral MF Style 140mm Reach 	

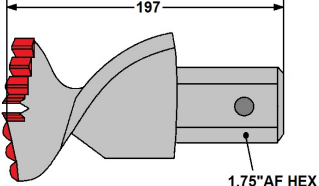
1 3/4" AF HEX CENTRE BITS

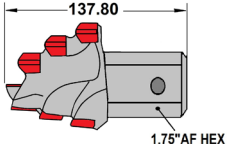

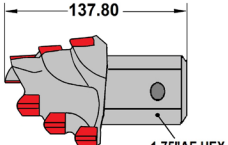

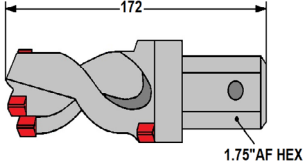
Part Number	Stock Code	Description	Drawing
EM8AL-HHD	1	Centre Bit Left Hand 140mm Reach 	
EM8AR-HHD	3	Centre Bit Right Hand 140mm Reach 	
EM8R-HHD	1	Centre Bit Right Hand Xmas Tree 	
EM8L-HHD	1	Centre Bit Left Hand Xmas Tree 	
EM8XL-HHD	1	Centre Bit Left Hand Xmas Tree 140mm Reach 	
EM8XR-HHD	3	Centre Bit Right Hand Xmas Tree 140mm Reach 	

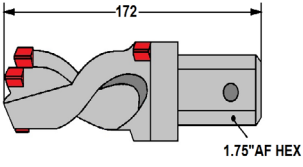
CENTRE BITS

1 3/4" AF HEX CENTRE BITS

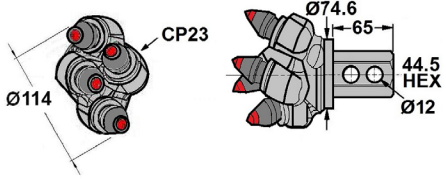

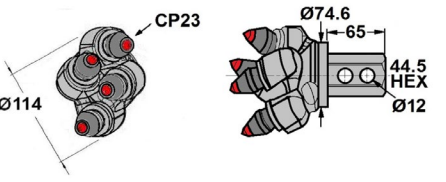

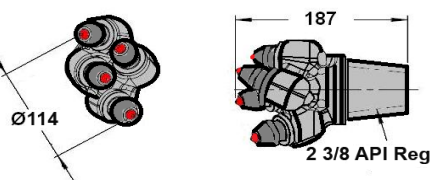
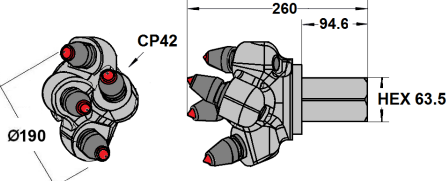
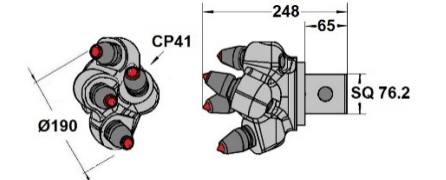
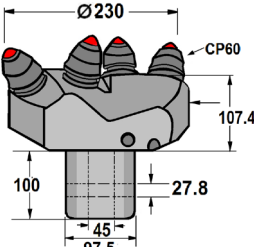
Part Number	Stock Code	Description	Drawing
EMF615-R	8	Centre Bit Fish Tail Pilot Right Hand NEW 	
EMF615-L	8	Centre Bit Fish Tail Pilot Left Hand 	
EMF620-R	1	Centre Bit Standard Right Hand NEW 	
EMF620-L	8	Centre Bit Standard Left Hand 	
EMF622-R	8	Centre Bit Standard Right Hand 	
EMF622-L	8	Centre Bit Standard Left Hand 	

1 3/4" AF & 2 1/2" HEX CENTRE BITS

Part Number	Stock Code	Description	Drawing
EM8RCP-H	1	Centre Bit Right Hand CP076 Series 	
EM8LCP-H	1	Centre Bit Left Hand CP076 Series 	
EM8RCP-TCF	3	Centre Bit Right Hand CP076 Series 	
EM10RCP-H	1	Centre Bit Right Hand CP.99 Series NEW	
EM10RCP-SQ75-65	1	Centre Bit Right Hand CP.99 Series 75 Square NEW	
EM18RCP-S	1	Centre Bit Right Hand CP116 Series NEW	

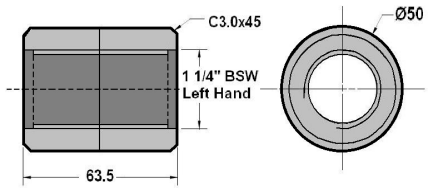

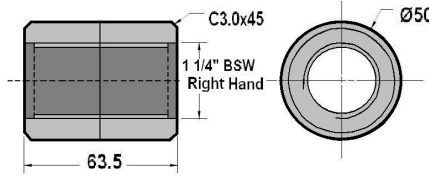
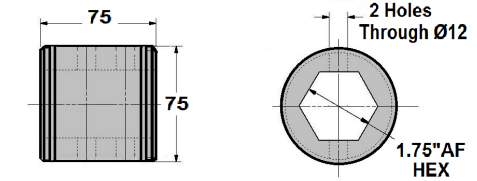
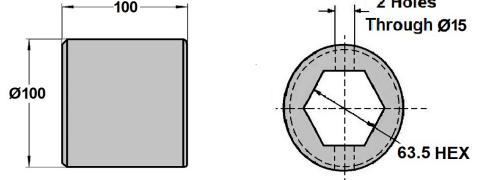
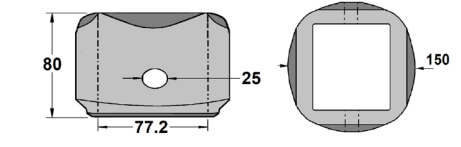
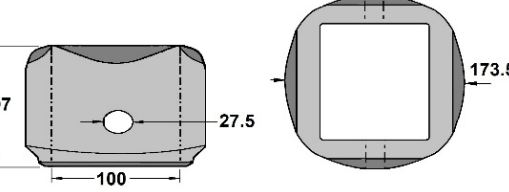

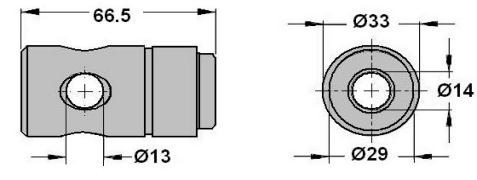
EM HOLDERS

EM HOLDERS

Part Number	Stock Code	Description	Drawing
EM59A	0	Boss Left Hand With Groove 	
EM59B	1	Boss Right Hand 	
EM59C	1	Boss Hex- 44.5mm AF NEW	
EM59H	1	Boss To Suit – EM10RCP-H and EM10LCP-H NEW	
EM59S-75SQ	1	Boss to Suit EM10RCP-SQ75-65 NEW	
EM59S	1	Boss Square for EM18RCP-S NEW	
EM68	8	EM25 Universal Holder 	

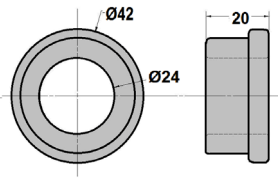

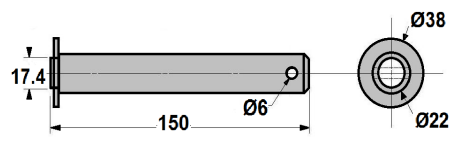
DRIVE PIN LOCATION BUSH

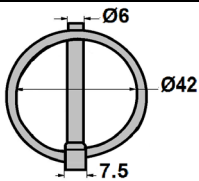
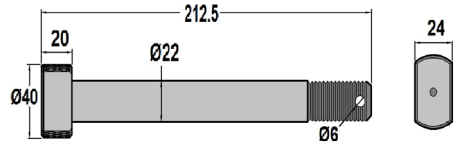
DRIVE PIN LOCATION BUSH

Part Number	Stock Code	Description	Drawing
EM9	8	Drive Pin Location Bush for Auger Shaft 	
EM10	8	Drive Location Pin with Clip 	
EM10CP	1	Clip Pin 	
EM10-AG	1	Drive Location Pin with Clip NEW	

PROLINE TOOLS

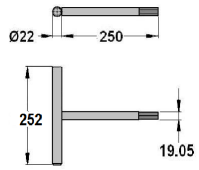
PROLINE TOOLS

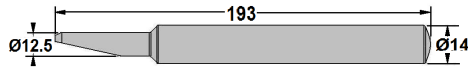
Part Number	Stock Code	Description	Drawing
EM11	8	Proline Holder Reaming Tool	
EM12-14	1	Proline Ejector 	

Disclaimer: While every care was taken in preparing this catalogue, Hard Metals Australia cannot accept any liability for accuracy of the information supplied.

HARDMETALS



CONTACT US

HEAD OFFICE

40 Peter Brock Drive
Eastern Creek NSW 2766

T +61 2 9009 4455

F +61 2 9009 4456

E sales@hardmetals.com

W www.hardmetals.com

SUPPLIER INFORMATION

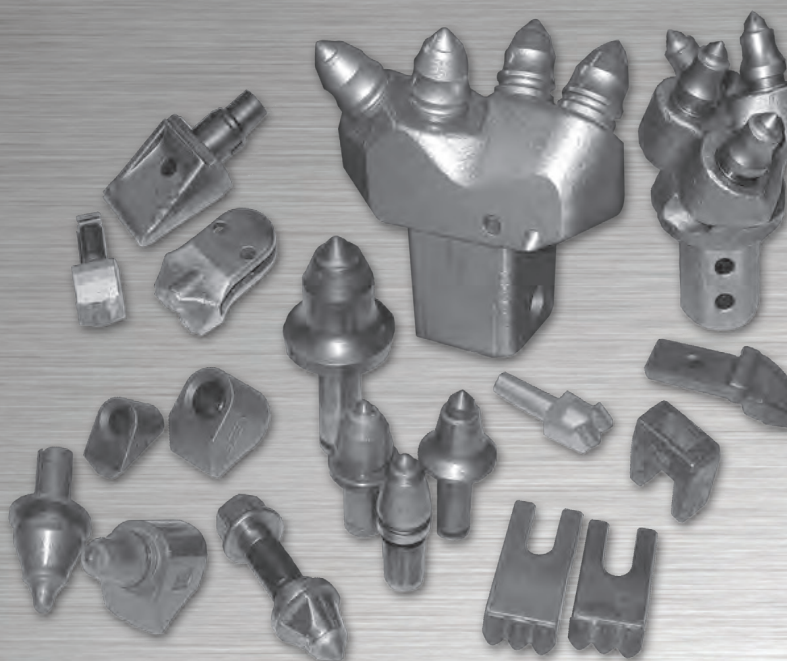

CAT2021-CT01